

GE Fastrac Program Service Dry-Type Transformers

GE Fastrac Program includes popular three-phase dry-type transformers of 15-500kVA.

Product numbers available include 9T83B3871 through 9T83B3877, and 9T40G0008 through 9T40G0011 on page 8-7 of this section.

Standard cycle: 5 days

GE Fastrac Program: 1 day

For more information on these products, order publications listed in Section 22.

General Information

Types QB, QMS, QL and TransforMore®8-2

General Purpose

Single-Phase TP-1, Aluminum8-4

Single-Phase TP-1, Copper8-5

Three-Phase TP-1, Aluminum8-6

Three-Phase TP-1, Copper8-8

K-Factor

Three-Phase TP-1, Aluminum8-9

Three-Phase TP-1, Copper8-13

K-Factor Low Noise

Three-Phase TP-1, Aluminum8-17

Three-Phase TP-1, Copper8-19

Low Noise

Three-Phase TP-1, Aluminum8-21

Three-Phase TP-1, Copper8-22

Noise Isolation – Guard I

Three-Phase TP-1, Aluminum8-23

Three-Phase TP-1, Copper8-24

Noise Isolation – Guard II8-25

Three-Phase TP-1, Aluminum8-26

Three-Phase TP-1, Copper8-27

Harmonic Mitigating – Guard III

Three-Phase TP-1, Copper8-28

Servicenter Mini-Unit Substations –

Integral Transformer and Distribution Center8-32

Single-Phase and Three-Phase8-33

Outlines, Dimensions, Wiring Diagrams8-34

New from GE!

–All New and Updated for TP-1

–**Find What You Need Faster** - New page headings and table format make product selection easier.

–**Easy Cross Reference** - Frame size listed with each model number. Use frame size to cross-reference dimensions, enclosure parts, and accessories.

–**Typical Transformer Performance Data** for common models

–**Expanded Lug Information**

–**New product offering:** Guard III Harmonic Mitigating

–**New product offering:** K-Factor Low Noise

Totally Enclosed, Nonventilated – TENV8-35

Aluminum and Copper8-36

Midtapped

Aluminum8-37

Copper8-38

Drive Isolation

Three-Phase8-39

Accessories and Lugs8-42

Enclosure Parts8-43

Wiring Diagrams8-44

Dimensions8-45

Typical Transformer Performance Data

General Purpose Aluminum8-46

General Purpose Copper8-47

K-Factor Aluminum8-48

K-Factor Copper8-49

General Purpose Transformers in Enclosures

Single-Phase8-50

Buck-Boost Encapsulated Transformers8-53

Selection Tables8-56

Connection Diagrams8-63

Open Core and Coil Transformers8-64

Machine Tool Applications8-65

Control8-66

Options and Fusing Guide8-68

Wiring Diagrams8-69

Outlines and Dimensions8-70

CE-Rated8-71



Transformers

General Information

Types QB, QMS, QL, and TransforMore®
600 Volts and Below

General Information

The complete family of transformers from GE provide quiet, reliable transformer operation.

All of the dry-type transformers through 1,000 kVA are UL listed under the requirements of Standard 506 and 1561. In addition, each transformer meets the requirements of NEMA ST-20, 1992. Type QB and QMS models are C-UL listed.

General-purpose transformers are rated 600 Volts and below for supplying appliance, lighting, and power loads from electrical distribution systems. Standard distribution voltages are 600, 480, and 240 Volts; standard load voltages are 480, 240, 208, and 120 Volts. The transformer is used to obtain the load voltage from the distribution voltage. Since no vaults are required for installation, these transformers can be located right at the load to provide the correct voltage for the application. This eliminates the need for long, costly, low-voltage feeders.

Construction

Types QB and QMS

Core and coils are contained within a NEMA 3R nonventilated weatherproof enclosure. Type QB and QMS units feature encapsulated core and coils.

Type QL

Units are enclosed in a NEMA 2 drip-proof metal enclosure with natural-draft ventilation. Core-and-coil assembly is mounted on rubber isolation pads to reduce noise. Weathershield kits are available for conversion to a NEMA 3R enclosure suitable for outdoor service. **All QL TP-1 model part numbers begin with 9T8.**

TransforMore®

Units utilize fan assisted cooling to achieve reduced size and improved efficiency. These units incorporate an audible alarm and shunt activated disconnect switch for improved safety. Weathershields are available to convert to NEMA 3R enclosure for outdoor service. **All TransforMore® TP-1 model part numbers begin with 9T4.**

Voltage Tap Arrangement

Transformer taps compensate for high or low line voltages. Standard NEMA, ANSI three-phase taps are two 5 percent taps below normal on transformers smaller than 30 kVA. This arrangement provides a 10 percent range of tap voltage adjustment.

Most standard QL units rated 15 through 500 kVA have available six universal voltage taps—four 2 1/2 percent below normal, and two 2 1/2 percent above normal. This arrangement provides a 15 percent range of tap voltage adjustment.

Temperature Class

Industry standards classify insulation systems in accordance with the rating system shown below.

Insulation System Classification			
Ambient	+ Winding Rise	+ Hot Spot	= Temp. Class
40°C	55°C	10°C	105°C
40°C	80°C	30°C	150°C
40°C	115°C	25°C	180°C
40°C	150°C	30°C	220°C

All standard, general-purpose, GE transformers meet all applicable NEMA, ANSI, UL, and IEEE standards.

The design life of transformers having different insulation systems is the same, since the allowable temperature rise of an insulation material system is predicated on a specified life for all insulation. The lower temperature systems are designed for the same life as higher temperature systems.

Sound Levels

All general-purpose transformers are as quiet, or quieter than the 1986 ANSI and NEMA Standards for sound levels. Average sound levels are warranted not to exceed the values listed for each load rating shown in the adjacent table. Sound characteristics vary between transformers of identical voltage and kVA rating. The range of variation may be 4 to 8 decibels.

These values apply only to specified test conditions because the characteristic of the installation can cause them to be higher under operating conditions. Where acoustical noise is deemed to be of unusual concern, proper steps should be taken during installation to minimize audible noise transmission.

TransforMore® sound levels are 54 dB when fans are off and operating at less than 50% rated load, and 65 dB when fans are operating.

Sound Levels (Decibels)¹ for 150°C Rise Models

kVA	Sound Levels
0 - 9	40
10 - 50	45
51 - 150	50
151 - 300	55
301 - 500	60

¹Measured per ANSI C89.2-1986.



Transformers

General Information

Types QB, QMS, QL, and TransforMore®
600 Volts and Below

Termination

Improved termination spacing and wiring compartment room gives greater flexibility in selecting various UL listed connectors for either copper or aluminum cable.

Product Number Selection Instructions

1. Establish phase and frequency
2. Determine the primary voltage—the voltage presently available
3. Determine the secondary voltage—the voltage needed at the load
4. Determine the kVA load, allowing room for expansion
5. Using the facts determined in the four steps, locate the transformer model in the listings on the following pages.



Type QB, .050 kVA-3 kVA, Single-Phase



Type QMS, 5 kVA-25 kVA, Single-Phase



Type QL, 15 kVA-167 kVA, Single-Phase, TP-1
15 kVA-225 kVA, Three-Phase, TP-1



TransforMore®, 150 kVA-1000 kVA, Three-Phase, TP-1



Publications and Reference: See Section 22 for a complete list of additional product-related publications

Transformers

General Purpose

Aluminum

Single-Phase TP-1

Section 8

150°C Rise NEMA 2

Input Voltage	Output Voltage	kVA	Taps	Wiring Diagram No. ¹	Approx. Net Weight (Lbs)	Frame Size	Product Number	List Price GO-66K
240 x 480 Volts	120/240 Volts	15	(+2,-4 2.7%)	23	185	E171	9T83B2670 ²	\$5703.10
240 x 480 Volts	120/240 Volts	25	(+2,-4 2.7%)	23	185	E171	9T83B2671	\$5330.00
240 x 480 Volts	120/240 Volts	37.5	(+2,-4 2.5%)	23	305	E172	9T83B2672	\$6631.00
240 x 480 Volts	120/240 Volts	50	(+2,-4 2.7%)	23	340	E173	9T83B2673	\$7914.00
240 x 480 Volts	120/240 Volts	75	(+2,-4 2.6%)	23	490	E174	9T83B2674	\$10023.00
240 x 480 Volts	120/240 Volts	100					9T83B2675	\$13110.00
240 x 480 Volts	120/240 Volts	167					9T83B2676	\$21917.00

115°C Rise NEMA 2

Input Voltage	Output Voltage	kVA	Taps	Wiring Diagram No. ¹	Approx. Net Weight (Lbs)	Frame Size	Product Number	List Price GO-66K
240 x 480 Volts	120/240 Volts	15	(+2,-4 2.7%)	23	185	E171	9T83B2670G15 ²	\$6799.85
240 x 480 Volts	120/240 Volts	25	(+2,-4 2.5%)	23	305	E172	9T83B2671G15 ²	\$7635.50
240 x 480 Volts	120/240 Volts	37.5	(+2,-4 2.5%)	23	305	E172	9T83B2672G15 ²	\$8780.83
240 x 480 Volts	120/240 Volts	50					9T83B2673G15	\$8715.00
240 x 480 Volts	120/240 Volts	75					9T83B2674G15	\$11020.00
240 x 480 Volts	120/240 Volts	100					9T83B2675G15	\$14420.00
240 x 480 Volts	120/240 Volts	167					9T83B2676G15	\$24105.00

80°C Rise NEMA 2

Input Voltage	Output Voltage	kVA	Taps	Wiring Diagram No. ¹	Approx. Net Weight (Lbs)	Frame Size	Product Number	List Price GO-66K
240 x 480 Volts	120/240 Volts	15	(+2,-4 2.7%)	23	185	E171	9T83B2670G80 ²	\$7677.25
240 x 480 Volts	120/240 Volts	25	(+2,-4 2.5%)	23	305	E172	9T83B2671G80	\$6810.00
240 x 480 Volts	120/240 Volts	37.5	(+2,-4 2.7%)	23	305	E172	9T83B2672G80 ²	\$9913.84
240 x 480 Volts	120/240 Volts	50					9T83B2673G80	\$9935.00
240 x 480 Volts	120/240 Volts	75					9T83B2674G80	\$12455.00
240 x 480 Volts	120/240 Volts	100					9T83B2675G80	\$16240.00
240 x 480 Volts	120/240 Volts	167					9T83B2676G80	\$26870.00

¹See page 8-44 for wiring diagrams.

²List Price GO-67B.



Transformers General Purpose Copper Single-Phase TP-1

Section 8

150°C Rise NEMA 2

Input Voltage	Output Voltage	kVA	Taps	Wiring Diagram No. ¹	Approx. Net Weight (Lbs)	Frame Size	Product Number	List Price GO-66KC
240 x 480 Volts	120/240 Volts	15	(+2,-4 2.3%)	23	255	E171	9T83C2570 ²	\$8335.30
240 x 480 Volts	120/240 Volts	25	(+2,-4 2.3%)	23	255	E171	9T83C2571	\$6242.00
240 x 480 Volts	120/240 Volts	37.5	(+2,-4 2.5%)	23	305	E172	9T83C2572	\$7895.00
240 x 480 Volts	120/240 Volts	50	(+2,-4 2.7%)	23	375	E173	9T83C2573	\$9557.00
240 x 480 Volts	120/240 Volts	75					9T83C2574	\$12094.00
240 x 480 Volts	120/240 Volts	100					9T83C2575	\$16093.00
240 x 480 Volts	120/240 Volts	167					9T83C2576	\$27617.00

115°C Rise NEMA 2

Input Voltage	Output Voltage	kVA	Taps	Wiring Diagram No. ¹	Approx. Net Weight (Lbs)	Frame Size	Product Number	List Price GO-66KC
240 x 480 Volts	120/240 Volts	15	(+2,-4 2.3%)	23	255	E171	9T83C2570G15 ²	\$9432.05
240 x 480 Volts	120/240 Volts	25	(+2,-4 2.3%)	23	255	E171	9T83C2571G15	\$10290.00
240 x 480 Volts	120/240 Volts	37.5	(+2,-4 2.5%)	23	305	E172	9T83C2572G15 ²	\$12179.86
240 x 480 Volts	120/240 Volts	50	(+2,-4 2.7%)	23	375	E173	9T83C2573G15	\$10510.00
240 x 480 Volts	120/240 Volts	75					9T83C2574G15	\$19950.00
240 x 480 Volts	120/240 Volts	100					9T83C2575G15	\$17705.00
240 x 480 Volts	120/240 Volts	167					9T83C2576G15	\$30370.00

80°C Rise NEMA 2

Input Voltage	Output Voltage	kVA	Taps	Wiring Diagram No. ¹	Approx. Net Weight (Lbs)	Frame Size	Product Number	List Price GO-66KC
240 x 480 Volts	120/240 Volts	15	(+2,-4 2.3%)	23	255	E171	9T83C2570G80	\$10309.45
240 x 480 Volts	120/240 Volts	25	(+2,-4 2.5%)	23	305	E172	9T83C2571G80 ²	\$11576.41
240 x 480 Volts	120/240 Volts	37.5	(+2,-4 2.5%)	23	305	E172	9T83C2572G80 ²	\$13312.87
240 x 480 Volts	120/240 Volts	50					9T83C2573G80	\$11960.00
240 x 480 Volts	120/240 Volts	75					9T83C2574G80	\$14995.00
240 x 480 Volts	120/240 Volts	100					9T83C2575G80	\$19885.00
240 x 480 Volts	120/240 Volts	167					9T83C2576G80	\$33760.00

¹See page 8-44 for wiring diagrams.

²List Price GO-67BC.



Publications and Reference: See Section 22 for a complete list of additional product-related publications

Transformers

General Purpose

Aluminum

Three-Phase TP-1

Advantages

- Quiet performance
- No-weld design – an industry first
- Comprehensive factory testing assures quality
- Easy, fast installation saves time
- Clear, comprehensive documentation and labeling enhance safety

Key Features

- Unique core and coil design makes QL transformers among the quietest available
- Core and coil assemblies are mounted on rubber isolation pads to reduce noise
- Bolted coil terminations are more reliable than welded terminations, and they eliminate weld failures and problems associated with welding and weld splatter
- Single-piece front/back is easily removable for service
- Accessible mounting flanges with front/back slotted mounting holes make installation easier
- 100% factory tested for shorts and coil integrity, current and loss, voltage, impedance and noise.
- NEMA 2 drip-proof enclosure is standard; weathershield kits are available for conversion to NEMA 3R outdoor configuration
- Qualified to the seismic requirements of IEEE-693-1997 and IBC-2003
- Copper or aluminum windings
- Copper ground strap
- Robust packaging with top and side protection protects against shipping damage



Type QL Transformer

Applications

- Commercial
- Industrial
- Motors
- Incandescent lighting
- Resistance heating
- Motor generators (without solid state drives)

Transformer Selection Guide

	Standard	Guard I	Guard II	Guard III	K-Factor (K=4)	K-Factor (K=13)	K-Factor (K=20)	K-Factor (K=50)	DIT	Service Center	TENV
Motors	X	X			X						
Incandescent Lighting	X	X			X						
Resistance Heating	X	X			X						
Motor Generators (without solid state drives)	X	X			X						
HID Lighting					X						
Induction Heaters					X						
Welders					X						
UPS with optional input filtering					X						
PLC & Solid state controls					X						
Multiple receptacle circuits in health care facilities						X					
UPS without optional input filtering						X					
Production or assembly line equipment						X					
Schools & Classroom facilities						X					
Surge Suppression			X								
Office Buildings		X	X	X		X					
SCR Variable Speed Drives							X	X			
Circuits with exclusive data processing equipment			X	X			X	X			
Critical Care facilities			X	X			X	X			
Hospital Operating Rooms			X	X			X	X			
X-ray equipment			X	X			X	X			
Computer Installations			X	X			X	X			
Programmable Controllers			X	X			X	X			
Instrumentation			X	X			X	X			
AC or DC Variable Speed Drives									X		
Rectifier outputs									X		
Temporary Power										X	
Airborne contaminants or dust-laden environments (indoor and outdoor)											X



Transformers

General Purpose

Aluminum

Three-Phase TP-1



Type QL Transformer
(Front Panel Removed)

150°C Rise NEMA 2

Input Voltage	Output Voltage	kVA	Taps	Wiring Diagram No. ¹	Approx. Net Weight (Lbs)	Frame Size	Product Number	List Price	GO Schedule
480 Volts	208Y/120 V	15	(+2,-4 2.6%)	12	265	EE71	9T83B3871	\$3682.00	66K
480 Volts	208Y/120 V	30	(+2,-4 2.5%)	12	375	EE72	9T83B3872	\$4503.00	66K
480 Volts	208Y/120 V	45	(+2,-4 2.3%)	12	430	EE73	9T83B3873	\$5575.00	66K
480 Volts	208Y/120 V	50	(+2,-4 2.3%)	12	600	EE74	9T83B3864	\$7414.00	67A
480 Volts	208Y/120 V	75	(+2,-4 2.5%)	12	600	EE74	9T83B3874	\$7950.00	66K
480 Volts	208Y/120 V	112.5	(+2,-4 2.6%)	12	760	EE75	9T83B3875	\$9998.00	66K
480 Volts	208Y/120 V	150	(+2,-4 2.6%)	12	904	EE76	9T83B3876	\$12734.00	66K
480 Volts	208Y/120 V	225	(+2,-4 2.6%)	12	1585	EE77	9T83B3877	\$16245.00	66K
480 Volts	208Y/120 V	300	(+2,-4 2.6%)	12	1020	FC78	9T40G0008	\$26595.00	66KG
480 Volts	208Y/120 V	400	(+2,-4 1.8%)	12	1585	FC79	9T40G0089	\$33966.00	66KG
480 Volts	208Y/120 V	500	(+2,-4 1.8%)	12	1585	FC79	9T40G0009	\$38930.00	66KG
480 Volts	208Y/120 V	750	(+2,-4 2.5%)	12	3250	FC67	9T40G0010	\$69350.00	66KG
480 Volts	208Y/120 V	1000	(+2,-4 2.5%)	12	3250	FC68	9T40G0011	\$104345.00	67AG

115°C Rise NEMA 2

Input Voltage	Output Voltage	kVA	Taps	Wiring Diagram No. ¹	Approx. Net Weight (Lbs)	Frame Size	Product Number	List Price	GO Schedule
480 Volts	208Y/120 V	15	(+2,-4 2.6%)	12	265	EE71	9T83B3871G15	\$7101.00	66K
480 Volts	208Y/120 V	30	(+2,-4 2.5%)	12	375	EE72	9T83B3872G15	\$7539.00	66K
480 Volts	208Y/120 V	45	(+2,-4 2.3%)	12	430	EE73	9T83B3873G15	\$9776.00	66K
480 Volts	208Y/120 V	50	(+2,-4 2.5%)	12	600	EE74	9T83B3864G15	\$9267.32	67A
480 Volts	208Y/120 V	75	(+2,-4 2.5%)	12	600	EE74	9T83B3874G15	\$12892.00	66K
480 Volts	208Y/120 V	112.5	(+2,-4 2.6%)	12	760	EE75	9T83B3875G15	\$15950.00	66K
480 Volts	208Y/120 V	150	(+2,-4 2.6%)	12	1585	EE77	9T83B3876G15	\$24731.00	66K
480 Volts	208Y/120 V	225	(+2,-4 2.6%)	12	1020	FC78	9T40G0007G51	\$28009.00	66KG
480 Volts	208Y/120 V	300	(+2,-4 1.8%)	12	1585	FC79	9T40G0008G51	\$43481.00	66KG
480 Volts	208Y/120 V	400	(+2,-4 1.8%)	12	1585	FC79	9T40G0089G51	\$61763.00	67AG
480 Volts	208Y/120 V	500	(+2,-4 2.5%)	12	3250	FC67	9T40G0009G51	\$68175.00	66KG
480 Volts	208Y/120 V	750	(+2,-4 2.6%)	12	3250	FC78	9T40G0010G51	\$77200.00	66KG

80°C Rise NEMA 2

Input Voltage	Output Voltage	kVA	Taps	Wiring Diagram No. ¹	Approx. Net Weight (Lbs)	Frame Size	Product Number	List Price	GO Schedule
480 Volts	208Y/120 V	15	(+2,-4 2.6%)	12	265	EE71	9T83B3871G80	\$7719.00	66K
480 Volts	208Y/120 V	30	(+2,-4 2.3%)	12	430	EE73	9T83B3872G80	\$8194.00	66K
480 Volts	208Y/120 V	45	(+2,-4 2.4%)	12	600	EE74	9T83B3873G80	\$9776.00	66K
480 Volts	208Y/120 V	75	(+2,-4 2.5%)	12	760	EE75	9T83B3874G80	\$14013.00	66K
480 Volts	208Y/120 V	112.5	(+2,-4 2.4%)	12	845	FC77	9T40G0005G81	\$17337.00	66KG
480 Volts	208Y/120 V	150	(+2,-4 2.4%)	12	845	FC77	9T40G0006G81	\$25768.00	66KG
480 Volts	208Y/120 V	225	(+2,-4 2.6%)	12	1020	FC78	9T40G0007G81	\$40968.00	66KG
480 Volts	208Y/120 V	300	(+2,-4 1.8%)	12	1585	FC79	9T40G0008G81	\$47262.00	66KG
480 Volts	208Y/120 V	500	(+2,-4 2.5%)	12	3250	FC68	9T40G0009G81	\$61750.00	66KG
480 Volts	208Y/120 V	750	(+2,-4 2.5%)	12	3250	FC67	9T40G0010G81	\$124436.85	67AG

¹See page 8-44 for wiring diagrams.



Publications and Reference: See Section 22 for a complete list of additional product-related publications

Transformers

General Purpose

Copper

Three-Phase TP-1

Section 8

150°C Rise NEMA 2

Input Voltage	Output Voltage	kVA	Taps	Wiring Diagram No. ¹	Approx. Net Weight (Lbs)	Frame Size	Product Number	List Price	GO Schedule
480 Volts	208Y/120 V	15	(+2,-4 2.6%)	12	290	EE71	9T83C9871	\$6175.00	66KC
480 Volts	208Y/120 V	30	(+2,-4 2.5%)	12	435	EE72	9T83C9872	\$6840.00	66KC
480 Volts	208Y/120 V	45	(+2,-4 2.3%)	12	510	EE73	9T83C9873	\$9785.00	66KC
480 Volts	208Y/120 V	75	(+2,-4 2.4%)	12	730	EE74	9T83C9874	\$12825.00	66KC
480 Volts	208Y/120 V	112.5	(+2,-4 2.6%)	12	820	EE75	9T83C9875	\$17575.00	66KC
480 Volts	208Y/120 V	150	(+2,-4 2.6%)	12	965	EE76	9T83C9876	\$22420.00	67AC
480 Volts	208Y/120 V	225	(+2,-4 2.6%)	12	1700	EE77	9T83C9877	\$26733.00	66KC
480 Volts	208Y/120 V	300	(+2,-4 2.6%)	12	1160	FC78	9T45G0008	\$40659.00	66KGC
480 Volts	208Y/120 V	500	(+2,-4 2.0%)	12	1700	FC79	9T45G0009	\$52819.00	66KGC
480 Volts	208Y/120 V	750	(+2,-4 2.5%)	12	4030	FC67	9T45G0010	\$79800.00	66KGC
480 Volts	208Y/120 V	1000	(+2,-4 2.5%)	12	4030	FC68	9T45G0011	\$95760.00	66KGC

115°C Rise NEMA 2

Input Voltage	Output Voltage	kVA	Taps	Wiring Diagram No. ¹	Approx. Net Weight (Lbs)	Frame Size	Product Number	List Price	GO Schedule
480 Volts	208Y/120 V	15	(+2,-4 2.6%)	12	290	EE71	9T83C9871G15	\$7640.00	66KC
480 Volts	208Y/120 V	30	(+2,-4 2.5%)	12	435	EE72	9T83C9872G15	\$7866.00	66KC
480 Volts	208Y/120 V	45	(+2,-4 2.3%)	12	510	EE73	9T83C9873G15	\$11253.00	66KC
480 Volts	208Y/120 V	75	(+2,-4 2.4%)	12	730	EE74	9T83C9874G15	\$14750.00	66KC
480 Volts	208Y/120 V	112.5	(+2,-4 2.6%)	12	820	EE75	9T83C9875G15	\$20211.00	66KC
480 Volts	208Y/120 V	150	(+2,-4 2.0%)	12	1700	EE77	9T83C9876G15	\$32681.00	66KC
480 Volts	208Y/120 V	225	(+2,-4 2.6%)	12	1160	FC78	9T45G0007G51	\$40203.00	66KGC
480 Volts	208Y/120 V	300	(+2,-4 2.0%)	12	1700	FC79	9T45G0008G51	\$46758.00	66KGC
480 Volts	208Y/120 V	500	(+2,-4 2.0%)	12	1700	FC79	9T45G0009G51	\$60742.00	66KGC
480 Volts	208Y/120 V	750	(+2,-4 2.5%)	12	4030	FC68	9T45G0010G51	\$95200.00	66KGC

80°C Rise NEMA 2

Input Voltage	Output Voltage	kVA	Taps	Wiring Diagram No. ¹	Approx. Net Weight (Lbs)	Frame Size	Product Number	List Price	GO Schedule
480 Volts	208Y/120 V	15	(+2,-4 2.5%)	12	435	EE72	9T83C9871G80	\$7719.00	66KC
480 Volts	208Y/120 V	30	(+2,-4 2.3%)	12	510	EE73	9T83C9872G80	\$8550.00	66KC
480 Volts	208Y/120 V	45	(+2,-4 2.4%)	12	730	EE74	9T83C9873G80	\$12231.00	66KC
480 Volts	208Y/120 V	75	(+2,-4 2.6%)	12	820	EE75	9T83C9874G80	\$16031.00	66KC
480 Volts	208Y/120 V	112.5	(+1,-5 7.0%)	12	820	EE75	9T83C9875G80	\$34270.00	66KC
480 Volts	208Y/120 V	150	(+2,-4 2.4%)	12	976	FC77	9T45G0006G81	\$28024.00	66KGC
480 Volts	208Y/120 V	225	(+2,-4 2.6%)	12	1160	FC78	9T45G0007G81	\$43699.00	66KGC
480 Volts	208Y/120 V	300	(+2,-4 2.0%)	12	1700	FC79	9T45G0008G81	\$50824.00	66KGC
480 Volts	208Y/120 V	500	(+2,-4 2.5%)	12	4030	FC68	9T45G0009G81	\$66025.00	66KGC
480 Volts	208Y/120 V	750	(+2,-4 2.5%)	12	4030	FC68	9T45G0010G81	\$147768.75	67AGC

¹See page 8-44 for wiring diagrams.



Transformers

K-Factor

Aluminum

Three-Phase TP-1

Product Description

These type QL transformers have passed the UL K-factor testing program. K-factor is a UL term related to harmonics. These units shall not exceed rated winding temperature rise at full load and rated K-factor. Neutrals are capable of handling 200% of rated secondary phase current.

Full-width copper electrostatic shielding is standard on all GE K-factor rated transformers. Effective coupling capacitance is 30 pf. Common mode noise attenuation averages 120 dB, and transverse mode noise attenuation averages 30 dB.

Application

For commercial applications with significance nonlinear electronic loading, use K=4 for systems with 50% connected nonlinear electronic loads; K=13 for systems with 100% connected nonlinear electronic loads.

Higher K-factor rated units are available for unique applications.



Type QL, UL K-Factor Transformer

K=4 150°C Rise NEMA 2

Input Voltage	Output Voltage	kVA	Taps	Wiring Diagram No. ¹	Approx. Net Weight (Lbs)	Frame Size	Product Number	List Price GO-67D
480 Volts Delta	208Y/120 Volts	15	(+2,-4 2.6%)	12	265	EE71	9T83B3461G03	\$5922.00
480 Volts Delta	208Y/120 Volts	30	(+2,-4 2.5%)	12	375	EE72	9T83B3462G03	\$7709.00
480 Volts Delta	208Y/120 Volts	45	(+2,-4 2.3%)	12	430	EE73	9T83B3463G03	\$9601.00
480 Volts Delta	208Y/120 Volts	75	(+2,-4 2.4%)	12	600	EE74	9T83B3464G03	\$13752.00
480 Volts Delta	208Y/120 Volts	112.5	(+2,-4 2.5%)	12	904	EE76	9T83B3465G03	\$20506.00
480 Volts Delta	208Y/120 Volts	150	(+2,-4 2.4%)	12	845	FC77	9T44G0006G03	\$23848.00
480 Volts Delta	208Y/120 Volts	225	(+2,-4 2.6%)	12	1020	FC78	9T44G0007G03	\$32050.00
480 Volts Delta	208Y/120 Volts	300	(+2,-4 1.8%)	12	1585	FC79	9T44G0008G03	\$44469.00
480 Volts Delta	208Y/120 Volts	500	(+2,-4 2.5%)	12	3250	FC68	9T44G0009G03	\$69996.00
480 Volts Delta	208Y/120 Volts	750	(+2,-4 2.5%)	12	3250	FC68	9T44G0010G03	\$104994.00

K=4 115°C Rise NEMA 2

Input Voltage	Output Voltage	kVA	Taps	Wiring Diagram No. ¹	Approx. Net Weight (Lbs)	Frame Size	Product Number	List Price GO-67D
480 Volts Delta	208Y/120 Volts	15	(+2,-4 2.5%)	12	375	EE72	9T83B3461G13	\$7019.00
480 Volts Delta	208Y/120 Volts	30	(+2,-4 2.3%)	12	430	EE73	9T83B3462G13	\$9136.00
480 Volts Delta	208Y/120 Volts	45	(+2,-4 2.4%)	12	600	EE74	9T83B3463G13	\$11379.00
480 Volts Delta	208Y/120 Volts	75	(+2,-4 2.6%)	12	760	EE75	9T83B3464G13	\$16298.00
480 Volts Delta	208Y/120 Volts	112.5	(+2,-4 2.5%)	12	904	EE76	9T83B3465G13	\$23923.00
480 Volts Delta	208Y/120 Volts	150	(+2,-4 2.4%)	12	845	FC77	9T44G0006G53	\$28264.00
480 Volts Delta	208Y/120 Volts	225	(+2,-4 2.6%)	12	1020	FC78	9T44G0007G53	\$37986.00
480 Volts Delta	208Y/120 Volts	300	(+2,-4 1.8%)	12	1585	FC79	9T44G0008G53	\$52704.00
480 Volts Delta	208Y/120 Volts	500	(+2,-4 2.5%)	12	3250	FC68	9T44G0009G53	\$82958.00

K=4 80°C Rise NEMA 2

Input Voltage	Output Voltage	kVA	Taps	Wiring Diagram No. ¹	Approx. Net Weight (Lbs)	Frame Size	Product Number	List Price GO-67D
480 Volts Delta	208Y/120 Volts	15	(+2,-4 2.5%)	12	375	EE72	9T83B3461G83	\$7896.60
480 Volts Delta	208Y/120 Volts	30	(+2,-4 2.3%)	12	430	EE73	9T83B3462G83	\$10278.38
480 Volts Delta	208Y/120 Volts	45	(+2,-4 2.4%)	12	600	EE74	9T83B3463G83	\$12801.93
480 Volts Delta	208Y/120 Volts	75	(+2,-4 2.5%)	12	904	EE76	9T83B3464G83	\$19863.48
480 Volts Delta	208Y/120 Volts	112.5	(+2,-4 2.4%)	12	845	FC77	9T44G0005G83	\$24607.00
480 Volts Delta	208Y/120 Volts	150	(+2,-4 2.4%)	12	845	FC77	9T44G0006G83	\$31797.00
480 Volts Delta	208Y/120 Volts	225	(+2,-4 2.6%)	12	1020	FC78	9T44G0007G83	\$42733.76
480 Volts Delta	208Y/120 Volts	300	(+2,-4 1.8%)	12	1585	FC79	9T44G0008G83	\$59292.00
480 Volts Delta	208Y/120 Volts	500	(+2,-4 2.5%)	12	3250	FC68	9T44G0009G83	\$93328.00

¹See page 8-44 for wiring diagrams.



Publications and Reference: See Section 22 for a complete list of additional product-related publications

Transformers

K-Factor

Aluminum

Three-Phase TP-1

Section 8

K=13 150°C Rise NEMA 2

Input Voltage	Output Voltage	kVA	Taps	Wiring Diagram No. ¹	Approx. Net Weight (Lbs)	Frame Size	Product Number	List Price GO-67D
480 Volts Delta	208V/120 Volts	15	(+2,-4 2.6%)	12	265	EE71	9T83B3471G03	\$6361.00
480 Volts Delta	208V/120 Volts	30	(+2,-4 2.5%)	12	375	EE72	9T83B3472G03	\$8280.00
480 Volts Delta	208V/120 Volts	45	(+2,-4 2.3%)	12	430	EE73	9T83B3473G03	\$10313.00
480 Volts Delta	208V/120 Volts	75	(+2,-4 2.6%)	12	760	EE75	9T83B3474G03	\$14770.00
480 Volts Delta	208V/120 Volts	112.5	(+2,-4 2.5%)	12	904	EE76	9T83B3475G03	\$21873.00
480 Volts Delta	208V/120 Volts	150	(+2,-4 2.4%)	12	845	FC77	9T41G0006G03	\$25615.00
480 Volts Delta	208V/120 Volts	225	(+2,-4 2.6%)	12	1020	FC78	9T41G0007G03	\$34424.00
480 Volts Delta	208V/120 Volts	300	(+2,-4 1.8%)	12	1585	FC79	9T41G0008G03	\$47763.00
480 Volts Delta	208V/120 Volts	500	(+2,-4 2.5%)	12	3250	FC68	9T41G0009G03	\$75181.00

K=13 115°C Rise NEMA 2

Input Voltage	Output Voltage	kVA	Taps	Wiring Diagram No. ¹	Approx. Net Weight (Lbs)	Frame Size	Product Number	List Price GO-67D
480 Volts Delta	208V/120 Volts	15	(+2,-4 2.5%)	12	375	EE72	9T83B3471G13	\$7458.00
480 Volts Delta	208V/120 Volts	30	(+2,-4 2.3%)	12	430	EE73	9T83B3472G13	\$9707.00
480 Volts Delta	208V/120 Volts	45	(+2,-4 2.4%)	12	600	EE74	9T83B3473G13	\$12091.00
480 Volts Delta	208V/120 Volts	75	(+2,-4 2.6%)	12	760	EE75	9T83B3474G13	\$17317.00
480 Volts Delta	208V/120 Volts	112.5	(+2,-4 2.4%)	12	845	FC77	9T41G0005G53	\$23240.00
480 Volts Delta	208V/120 Volts	150	(+2,-4 2.4%)	12	845	FC77	9T41G0006G53	\$30031.00
480 Volts Delta	208V/120 Volts	225	(+2,-4 2.6%)	12	1020	FC78	9T41G0007G53	\$40360.00
480 Volts Delta	208V/120 Volts	300	(+2,-4 2.5%)	12	3250	FC68	9T41G0008G53	\$55998.00

K=13 80°C Rise NEMA 2

Input Voltage	Output Voltage	kVA	Taps	Wiring Diagram No. ¹	Approx. Net Weight (Lbs)	Frame Size	Product Number	List Price GO-67D
480 Volts Delta	208V/120 Volts	15	(+2,-4 2.5%)	12	375	EE72	9T83B3471G83	\$8335.30
480 Volts Delta	208V/120 Volts	30	(+2,-4 2.3%)	12	430	EE73	9T83B3472G83	\$10849.00
480 Volts Delta	208V/120 Volts	45	(+2,-4 2.6%)	12	760	EE75	9T83B3473G83	\$13513.00
480 Volts Delta	208V/120 Volts	75	(+2,-4 2.5%)	12	960	EE76	9T83B3474G83	\$20882.00
480 Volts Delta	208V/120 Volts	112.5	(+2,-4 2.4%)	12	845	FC77	9T41G0005G83	\$25974.00
480 Volts Delta	208V/120 Volts	150	(+2,-4 2.6%)	12	1020	FC78	9T41G0006G83	\$33564.00
480 Volts Delta	208V/120 Volts	225	(+2,-4 1.8%)	12	1585	FC79	9T41G0007G83	\$45108.00
480 Volts Delta	208V/120 Volts	300	(+2,-4 2.5%)	12	3250	FC68	9T41G0008G83	\$62586.00

¹See page 8-44 for wiring diagrams.



Transformers

K-Factor

Aluminum

Three-Phase TP-1

K=20 150°C Rise NEMA 2

Input Voltage	Output Voltage	kVA	Taps	Wiring Diagram No. ¹	Approx. Net Weight (Lbs)	Frame Size	Product Number	List Price GO-67D
480 Volts Delta	208Y/120 Volts	15	(+2,-4 2.6%)	12	265	EE71	9T83B3481G03	\$7677.25
480 Volts Delta	208Y/120 Volts	30	(+2,-4 2.3%)	12	430	EE73	9T83B3482G03	\$9992.87
480 Volts Delta	208Y/120 Volts	45	(+2,-4 2.3%)	12	430	EE73	9T83B3483G03	\$12446.32
480 Volts Delta	208Y/120 Volts	75	(+2,-4 2.6%)	12	760	EE75	9T83B3484G03	\$17826.20
480 Volts Delta	208Y/120 Volts	112.5	(+2,-4 2.4%)	12	845	FC77	9T42G0005G03	\$23923.00
480 Volts Delta	208Y/120 Volts	150	(+2,-4 2.4%)	12	845	FC77	9T42G0006G03	\$30914.13
480 Volts Delta	208Y/120 Volts	225	(+2,-4 2.6%)	12	1020	FC78	9T42G0007G03	\$41546.71
480 Volts Delta	208Y/120 Volts	300	(+2,-4 1.8%)	12	1585	FC79	9T42G0008G03	\$57645.00

K=20 115°C Rise NEMA 2

Input Voltage	Output Voltage	kVA	Taps	Wiring Diagram No. ¹	Approx. Net Weight (Lbs)	Frame Size	Product Number	List Price GO-67D
480 Volts Delta	208Y/120 Volts	15	(+2,-4 2.5%)	12	375	EE72	9T83B3481G13	\$8774.00
480 Volts Delta	208Y/120 Volts	30	(+2,-4 2.3%)	12	430	EE73	9T83B3482G13	\$11420.42
480 Volts Delta	208Y/120 Volts	45	(+2,-4 2.4%)	12	600	EE74	9T83B3483G13	\$14224.37
480 Volts Delta	208Y/120 Volts	75	(+2,-4 2.5%)	12	904	EE76	9T83B3484G13	\$21900.76
480 Volts Delta	208Y/120 Volts	112.5	(+2,-4 2.4%)	12	845	FC77	9T42G0005G53	\$27340.74
480 Volts Delta	208Y/120 Volts	150	(+2,-4 2.6%)	12	1020	FC78	9T42G0006G53	\$35330.43
480 Volts Delta	208Y/120 Volts	225	(+2,-4 1.8%)	12	1585	FC79	9T42G0007G53	\$47481.96
480 Volts Delta	208Y/120 Volts	300	(+2,-4 2.5%)	12	3250	FC68	9T42G0008G53	\$65880.45

K=20 80°C Rise NEMA 2

Input Voltage	Output Voltage	kVA	Taps	Wiring Diagram No. ¹	Approx. Net Weight (Lbs)	Frame Size	Product Number	List Price GO-67D
480 Volts Delta	208Y/120 Volts	15	(+2,-4 2.5%)	12	375	EE72	9T83B3481G83	\$9651.40
480 Volts Delta	208Y/120 Volts	30	(+2,-4 2.4%)	12	600	EE74	9T83B3482G83	\$12562.46
480 Volts Delta	208Y/120 Volts	45	(+2,-4 2.6%)	12	760	EE75	9T83B3483G83	\$15646.81
480 Volts Delta	208Y/120 Volts	75	(+2,-4 2.4%)	12	845	FC77	9T42G0004G83	\$22410.08
480 Volts Delta	208Y/120 Volts	112.5	(+2,-4 2.4%)	12	845	FC77	9T42G0005G83	\$30074.81
480 Volts Delta	208Y/120 Volts	150	(+2,-4 2.6%)	12	1020	FC78	9T42G0006G83	\$38863.47
480 Volts Delta	208Y/120 Volts	225	(+2,-4 2.5%)	12	3250	FC68	9T42G0007G83	\$52230.15

¹See page 8-44 for wiring diagrams.



Publications and Reference: See Section 22 for a complete list of additional product-related publications

Transformers

K-Factor

Aluminum

Three-Phase TP-1

Section 8

K=30 150°C Rise NEMA 2

Input Voltage	Output Voltage	kVA	Taps	Wiring Diagram No. ¹	Approx. Net Weight (Lbs)	Frame Size	Product Number	List Price GO-67D
480 Volts Delta	208Y/120 Volts	15	(+2,-4 2.6%)	12	265	EE71	9T83B3491G03	\$8335.30
480 Volts Delta	208Y/120 Volts	30	(+2,-4 2.3%)	12	430	EE73	9T83B3492G03	\$10849.40
480 Volts Delta	208Y/120 Volts	45	(+2,-4 2.4%)	12	600	EE74	9T83B3493G03	\$13513.15
480 Volts Delta	208Y/120 Volts	75	(+2,-4 2.6%)	12	760	EE75	9T83B3494G03	\$19354.16
480 Volts Delta	208Y/120 Volts	112.5	(+2,-4 2.4%)	12	845	FC77	9T43G0005G03	\$25973.70
480 Volts Delta	208Y/120 Volts	150	(+2,-4 2.6%)	12	1020	FC78	9T43G0006G03	\$33563.91
480 Volts Delta	208Y/120 Volts	225	(+2,-4 1.8%)	12	1585	FC79	9T43G0007G03	\$45107.86

K=30 115°C Rise NEMA 2

Input Voltage	Output Voltage	kVA	Taps	Wiring Diagram No. ¹	Approx. Net Weight (Lbs)	Frame Size	Product Number	List Price GO-67D
480 Volts Delta	208Y/120 Volts	15	(+2,-4 2.5%)	12	375	EE72	9T83B3491G13	\$9432.05
480 Volts Delta	208Y/120 Volts	30	(+2,-4 2.3%)	12	430	EE73	9T83B3492G13	\$12276.95
480 Volts Delta	208Y/120 Volts	45	(+2,-4 2.4%)	12	600	EE74	9T83B3493G13	\$15291.20
480 Volts Delta	208Y/120 Volts	75	(+2,-4 2.5%)	12	904	EE76	9T83B3494G13	\$23428.72
480 Volts Delta	208Y/120 Volts	112.5	(+2,-4 2.4%)	12	845	FC77	9T43G0005G53	\$29391.29
480 Volts Delta	208Y/120 Volts	150	(+2,-4 2.6%)	12	1020	FC78	9T43G0006G53	\$37980.21
480 Volts Delta	208Y/120 Volts	225	(+2,-4 2.5%)	12	3250	FC68	9T43G0007G53	\$51043.10

K=30 80°C Rise NEMA 2

Input Voltage	Output Voltage	kVA	Taps	Wiring Diagram No. ¹	Approx. Net Weight (Lbs)	Frame Size	Product Number	List Price GO-67D
480 Volts Delta	208Y/120 Volts	15	(+2,-4 2.5%)	12	375	EE72	9T83B3491G83	\$10309.45
480 Volts Delta	208Y/120 Volts	30	(+2,-4 2.4%)	12	600	EE74	9T83B3492G83	\$13419.00
480 Volts Delta	208Y/120 Volts	45	(+2,-4 2.6%)	12	760	EE75	9T83B3493G83	\$16713.64
480 Volts Delta	208Y/120 Volts	75	(+2,-4 2.4%)	12	845	FC77	9T43G0004G83	\$23938.04
480 Volts Delta	208Y/120 Volts	112.5	(+2,-4 2.6%)	12	1020	FC78	9T43G0005G83	\$34175.92
480 Volts Delta	208Y/120 Volts	150	(+2,-4 2.6%)	12	1020	FC78	9T43G0006G83	\$41513.25

¹See page 8-44 for wiring diagrams.



Transformers

K-Factor

Copper

Three-Phase TP-1

K=4 150°C Rise NEMA 2

Input Voltage	Output Voltage	kVA	Taps	Wiring Diagram No. ¹	Approx. Net Weight (Lbs)	Frame Size	Product Number	List Price GO-67DC
480 Volts Delta	208V/120 Volts	15	(+2,-4 2.6%)	12	290	EE71	9T83C9461G03	\$8554.65
480 Volts Delta	208V/120 Volts	30	(+2,-4 2.5%)	12	435	EE72	9T83C9462G03	\$12495.00
480 Volts Delta	208V/120 Volts	45	(+2,-4 2.3%)	12	535	EE73	9T83C9463G03	\$13870.00
480 Volts Delta	208V/120 Volts	75	(+2,-4 2.4%)	12	730	EE74	9T83C9464G03	\$19863.48
480 Volts Delta	208V/120 Volts	112.5	(+2,-4 2.4%)	12	965	EE76	9T83C9465G03	\$26657.22
480 Volts Delta	208V/120 Volts	150	(+2,-4 2.4%)	12	976	FC77	9T49G0006G03	\$31797.00
480 Volts Delta	208V/120 Volts	225	(+2,-4 2.6%)	12	1160	FC78	9T49G0007G03	\$42734.00
480 Volts Delta	208V/120 Volts	300	(+2,-4 2.0%)	12	1700	FC79	9T49G0008G03	\$59292.00
480 Volts Delta	208V/120 Volts	500	(+2,-4 2.5%)	12	4030	FC68	9T49G0009G03	\$101104.94

K=4 115°C Rise NEMA 2

Input Voltage	Output Voltage	kVA	Taps	Wiring Diagram No. ¹	Approx. Net Weight (Lbs)	Frame Size	Product Number	List Price GO-67DC
480 Volts Delta	208V/120 Volts	15	(+2,-4 2.5%)	12	435	EE72	9T83C9461G13	\$9651.40
480 Volts Delta	208V/120 Volts	30	(+2,-4 2.3%)	12	535	EE73	9T83C9462G13	\$12562.46
480 Volts Delta	208V/120 Volts	45	(+2,-4 2.4%)	12	730	EE74	9T83C9463G13	\$15646.81
480 Volts Delta	208V/120 Volts	75	(+2,-4 2.6%)	12	820	EE75	9T83C9464G13	\$22410.08
480 Volts Delta	208V/120 Volts	112.5	(+2,-4 2.4%)	12	976	FC77	9T49G0005G53	\$28024.00
480 Volts Delta	208V/120 Volts	150	(+2,-4 2.4%)	12	976	FC77	9T49G0006G53	\$36214.00
480 Volts Delta	208V/120 Volts	225	(+2,-4 2.6%)	12	1160	FC78	9T49G0007G53	\$48669.00
480 Volts Delta	208V/120 Volts	300	(+2,-4 2.0%)	12	1700	FC79	9T49G0008G53	\$67527.00
480 Volts Delta	208V/120 Volts	500	(+2,-4 2.5%)	12	4030	FC68	9T49G0009G53	\$114067.11

K=4 80°C Rise NEMA 2

Input Voltage	Output Voltage	kVA	Taps	Wiring Diagram No. ¹	Approx. Net Weight (Lbs)	Frame Size	Product Number	List Price GO-67DC
480 Volts Delta	208V/120 Volts	15	(+2,-4 2.5%)	12	435	EE72	9T83C9461G83	\$10528.80
480 Volts Delta	208V/120 Volts	30	(+2,-4 2.3%)	12	535	EE73	9T83C9462G83	\$13704.51
480 Volts Delta	208V/120 Volts	45	(+2,-4 2.4%)	12	730	EE74	9T83C9463G83	\$17069.24
480 Volts Delta	208V/120 Volts	75	(+2,-4 2.4%)	12	965	EE76	9T83C9464G83	\$24447.36
480 Volts Delta	208V/120 Volts	112.5	(+2,-4 2.4%)	12	976	FC77	9T49G0005G83	\$30758.00
480 Volts Delta	208V/120 Volts	150	(+2,-4 2.4%)	12	976	FC77	9T49G0006G83	\$39747.00
480 Volts Delta	208V/120 Volts	225	(+2,-4 2.6%)	12	1160	FC78	9T49G0007G83	\$53417.00
480 Volts Delta	208V/120 Volts	300	(+2,-4 2.0%)	12	1700	FC79	9T49G0008G83	\$74116.00
480 Volts Delta	208V/120 Volts	500	(+2,-4 2.5%)	12	4030	FC68	9T49G0009G83	\$124436.85

¹See page 8-44 for wiring diagrams.



Publications and Reference: See Section 22 for a complete list of additional product-related publications

Transformers

K-Factor

Copper

Three-Phase TP-1

Section 8

K=13 150°C Rise NEMA 2

Input Voltage	Output Voltage	kVA	Taps	Wiring Diagram No. ¹	Approx. Net Weight (Lbs)	Frame Size	Product Number	List Price GO-67DC
480 Volts Delta	208Y/120 Volts	15	(+2,-4 2.6%)	12	290	EE71	9T83C9471G03	\$8993.35
480 Volts Delta	208Y/120 Volts	30	(+2,-4 2.5%)	12	435	EE72	9T83C9472G03	\$11705.93
480 Volts Delta	208Y/120 Volts	45	(+2,-4 2.4%)	12	730	EE74	9T83C9473G03	\$14579.98
480 Volts Delta	208Y/120 Volts	75	(+2,-4 2.6%)	12	820	EE75	9T83C9474G03	\$20882.12
480 Volts Delta	208Y/120 Volts	112.5	(+2,-4 2.4%)	12	965	EE76	9T83C9475G03	\$28024.26
480 Volts Delta	208Y/120 Volts	150	(+2,-4 2.4%)	12	976	FC77	9T46G0006G03	\$33564.00
480 Volts Delta	208Y/120 Volts	225	(+2,-4 2.6%)	12	1160	FC78	9T46G0007G03	\$45108.00
480 Volts Delta	208Y/120 Volts	300	(+2,-4 2.0%)	12	1700	FC79	9T46G0008G03	\$62586.00
480 Volts Delta	208Y/120 Volts	500	(+2,-4 2.5%)	12	4030	FC68	9T46G0009G03	\$106290.00

K=13 115°C Rise NEMA 2

Input Voltage	Output Voltage	kVA	Taps	Wiring Diagram No. ¹	Approx. Net Weight (Lbs)	Frame Size	Product Number	List Price GO-67DC
480 Volts Delta	208Y/120 Volts	15	(+2,-4 2.5%)	12	435	EE72	9T83C9471G13	\$12312.00
480 Volts Delta	208Y/120 Volts	30	(+2,-4 2.3%)	12	535	EE73	9T83C9472G13	\$15305.00
480 Volts Delta	208Y/120 Volts	45	(+2,-4 2.4%)	12	730	EE74	9T83C9473G13	\$16358.03
480 Volts Delta	208Y/120 Volts	75	(+2,-4 2.6%)	12	820	EE75	9T83C9474G13	\$23428.72
480 Volts Delta	208Y/120 Volts	112.5	(+2,-4 2.4%)	12	976	FC77	9T46G0005G53	\$29391.00
480 Volts Delta	208Y/120 Volts	150	(+2,-4 2.4%)	12	976	FC77	9T46G0006G53	\$37980.00
480 Volts Delta	208Y/120 Volts	225	(+2,-4 2.6%)	12	1160	FC78	9T46G0007G53	\$51043.00
480 Volts Delta	208Y/120 Volts	300	(+2,-4 2.0%)	12	1700	FC79	9T46G0008G53	\$70821.00
480 Volts Delta	208Y/120 Volts	500	(+2,-4 2.5%)	12	4030	FC68	9T46G0009G53	\$119251.98

K=13 80°C Rise NEMA 2

Input Voltage	Output Voltage	kVA	Taps	Wiring Diagram No. ¹	Approx. Net Weight (Lbs)	Frame Size	Product Number	List Price GO-67DC
480 Volts Delta	208Y/120 Volts	15	(+2,-4 2.5%)	12	435	EE72	9T83C9471G83	\$10967.50
480 Volts Delta	208Y/120 Volts	30	(+2,-4 2.3%)	12	535	EE73	9T83C9472G83	\$14275.53
480 Volts Delta	208Y/120 Volts	45	(+2,-4 2.6%)	12	820	EE75	9T83C9473G83	\$17780.46
480 Volts Delta	208Y/120 Volts	75		12			9T83C9474G83	\$26993.96
480 Volts Delta	208Y/120 Volts	112.5	(+2,-4 2.4%)	12	976	FC77	9T46G0005G83	\$32125.00
480 Volts Delta	208Y/120 Volts	150	(+2,-4 2.6%)	12	1160	FC78	9T46G0006G83	\$41513.00
480 Volts Delta	208Y/120 Volts	225	(+2,-4 2.0%)	12	1700	FC79	9T46G0007G83	\$55791.00
480 Volts Delta	208Y/120 Volts	300	(+2,-4 2.5%)	12	4030	FC68	9T46G0008G83	\$82350.56

¹See page 8-44 for wiring diagrams.



Transformers

K-Factor

Copper

Three-Phase TP-1

K=20 150°C Rise NEMA 2

Input Voltage	Output Voltage	kVA	Taps	Wiring Diagram No. ¹	Approx. Net Weight (Lbs)	Frame Size	Product Number	List Price GO-67DC
480 Volts Delta	208V/120 Volts	15	(+2,-4 2.6%)	12	290	EE71	9T83C9481G03	\$10309.45
480 Volts Delta	208V/120 Volts	30	(+2,-4 2.3%)	12	535	EE73	9T83C9482G03	\$13418.99
480 Volts Delta	208V/120 Volts	45	(+2,-4 2.4%)	12	730	EE74	9T83C9483G03	\$16713.37
480 Volts Delta	208V/120 Volts	75	(+2,-4 2.6%)	12	820	EE75	9T83C9484G03	\$23938.04
480 Volts Delta	208V/120 Volts	112.5	(+2,-4 2.4%)	12	976	FC77	9T47G0005G03	\$30074.81
480 Volts Delta	208V/120 Volts	150	(+2,-4 2.4%)	12	976	FC77	9T47G0006G03	\$38863.47
480 Volts Delta	208V/120 Volts	225	(+2,-4 2.6%)	12	1160	FC78	9T47G0007G03	\$52230.15
480 Volts Delta	208V/120 Volts	300	(+2,-4 2.0%)	12	1700	FC79	9T47G0008G03	\$72468.49

K=20 115°C Rise NEMA 2

Input Voltage	Output Voltage	kVA	Taps	Wiring Diagram No. ¹	Approx. Net Weight (Lbs)	Frame Size	Product Number	List Price GO-67DC
480 Volts Delta	208V/120 Volts	15	(+2,-4 2.5%)	12	435	EE72	9T83C9481G13	\$11406.20
480 Volts Delta	208V/120 Volts	30	(+2,-4 2.3%)	12	535	EE73	9T83C9482G13	\$14846.55
480 Volts Delta	208V/120 Volts	45	(+2,-4 2.4%)	12	730	EE74	9T83C9483G13	\$18491.68
480 Volts Delta	208V/120 Volts	75	(+2,-4 2.4%)	12	976	FC77	9T47G0004G53	\$24956.68
480 Volts Delta	208V/120 Volts	112.5	(+2,-4 2.4%)	12	976	FC77	9T47G0005G53	\$33492.00
480 Volts Delta	208V/120 Volts	150	(+2,-4 2.4%)	12	976	FC77	9T47G0006G53	\$43279.78
480 Volts Delta	208V/120 Volts	225	(+2,-4 2.0%)	12	1780	FC79	9T47G0007G53	\$58165.40
480 Volts Delta	208V/120 Volts	300	(+2,-4 2.5%)	12	4030	FC68	9T47G0008G53	\$80703.55

K=20 80°C Rise NEMA 2

Input Voltage	Output Voltage	kVA	Taps	Wiring Diagram No. ¹	Approx. Net Weight (Lbs)	Frame Size	Product Number	List Price GO-67DC
480 Volts Delta	208V/120 Volts	15	(+2,-4 2.5%)	12	435	EE72	9T83C9481G83	\$12283.60
480 Volts Delta	208V/120 Volts	30	(+2,-4 2.4%)	12	730	EE74	9T83C9482G83	\$15988.59
480 Volts Delta	208V/120 Volts	45	(+2,-4 2.6%)	12	820	EE75	9T83C9483G83	\$19914.12
480 Volts Delta	208V/120 Volts	75	(+2,-4 2.4%)	12	976	FC77	9T47G0004G83	\$26993.96
480 Volts Delta	208V/120 Volts	150	(+2,-4 2.6%)	12	1160	FC78	9T47G0006G83	\$46812.82

¹See page 8-44 for wiring diagrams.



Publications and Reference: See Section 22 for a complete list of additional product-related publications

Transformers

K-Factor

Copper

Three-Phase TP-1

Section 8

K=30 150°C Rise NEMA 2

Input Voltage	Output Voltage	kVA	Taps	Wiring Diagram No. ¹	Approx. Net Weight (Lbs)	Frame Size	Product Number	List Price GO-67DC
480 Volts Delta	208V/120 Volts	15	(+2,-4 2.6%)	12	290	EE71	9T83C9491G03	\$10967.50
480 Volts Delta	208V/120 Volts	30	(+2,-4 2.3%)	12	535	EE73	9T83C9492G03	\$14275.53
480 Volts Delta	208V/120 Volts	45	(+2,-4 2.4%)	12	730	EE74	9T83C9493G03	\$17780.46
480 Volts Delta	208V/120 Volts	75	(+2,-4 2.6%)	12	820	EE75	9T83C9494G03	\$25446.00
480 Volts Delta	208V/120 Volts	112.5	(+2,-4 2.4%)	12	976	FC77	9T48G0005G03	\$32125.37
480 Volts Delta	208V/120 Volts	150	(+2,-4 2.4%)	12	976	FC77	9T48G0006G03	\$41513.25
480 Volts Delta	208V/120 Volts	225	(+2,-4 2.0%)	12	1700	FC79	9T48G0007G03	\$55791.30

K=30 115°C Rise NEMA 2

Input Voltage	Output Voltage	kVA	Taps	Wiring Diagram No. ¹	Approx. Net Weight (Lbs)	Frame Size	Product Number	List Price GO-67DC
480 Volts Delta	208V/120 Volts	15	(+2,-4 2.5%)	12	435	EE72	9T83C9491G13	\$12064.25
480 Volts Delta	208V/120 Volts	30	(+2,-4 2.3%)	12	535	EE73	9T83C9492G13	\$15703.08
480 Volts Delta	208V/120 Volts	45	(+2,-4 2.4%)	12	730	EE74	9T83C9493G13	\$19558.51
480 Volts Delta	208V/120 Volts	75	(+2,-4 2.4%)	12	976	FC77	9T48G0004G53	\$26484.64
480 Volts Delta	208V/120 Volts	112.5	(+2,-4 2.4%)	12	976	FC77	9T48G0005G53	\$35542.96
480 Volts Delta	208V/120 Volts	150	(+2,-4 2.6%)	12	1160	FC78	9T48G0006G53	\$45929.56
480 Volts Delta	208V/120 Volts	225	(+2,-4 2.0%)	12	1700	FC79	9T48G0007G53	\$61726.54

K=30 80°C Rise NEMA 2

Input Voltage	Output Voltage	kVA	Taps	Wiring Diagram No. ¹	Approx. Net Weight (Lbs)	Frame Size	Product Number	List Price GO-67DC
480 Volts Delta	208V/120 Volts	15	(+2,-4 2.5%)	12	435	EE72	9T83C9491G83	\$12941.65
480 Volts Delta	208V/120 Volts	30	(+2,-4 2.4%)	12	730	EE74	9T83C9492G83	\$16845.12
480 Volts Delta	208V/120 Volts	45	(+2,-4 2.6%)	12	820	EE75	9T83C9493G83	\$20980.95
480 Volts Delta	208V/120 Volts	75	(+2,-4 2.4%)	12	976	FC77	9T48G0004G83	\$28522.00
480 Volts Delta	208V/120 Volts	112.5	(+2,-4 2.4%)	12	976	FC77	9T48G0005G83	\$38277.03
480 Volts Delta	208V/120 Volts	150	(+2,-4 2.6%)	12	1160	FC78	9T48G0006G83	\$49462.60

¹See page 8-44 for wiring diagrams.



Transformers

K-Factor Low Noise

Aluminum

Three-Phase TP-1

K=4 150°C Rise

Input Voltage	Output Voltage	kVA	Taps	Wiring Diagram No. ¹	Approx. Net Weight (Lbs)	Frame Size	Product Number	List Price GO-67D
480	208Y/120	15	(+2,-4 2.6%)	12	265	EE71	9T83B3421G03	\$10336.00
480	208Y/120	30	(+2,-4 2.5%)	12	375	EE72	9T83B3422G03	\$10517.00
480	208Y/120	45	(+2,-4 2.3%)	12	430	EE73	9T83B3423G03	\$15267.00
480	208Y/120	75	(+2,-4 2.4%)	12	600	EE74	9T83B3424G03	\$15913.00
480	208Y/120	112.5	(+2,-4 2.5%)	12	904	EE76	9T83B3425G03	\$35606.00

K=4 115°C Rise

Input Voltage	Output Voltage	kVA	Taps	Wiring Diagram No. ¹	Approx. Net Weight (Lbs)	Frame Size	Product Number	List Price GO-67D
480	208Y/120	15	(+2,-4 2.5%)	12	375	EE72	9T83B3421G13	\$10555.00
480	208Y/120	30	(+2,-4 2.3%)	12	430	EE73	9T83B3422G13	\$11267.00
480	208Y/120	75	(+2,-4 2.6%)	12	760	EE75	9T83B3424G13	\$18383.00
480	208Y/120	112.5	(+2,-4 2.5%)	12	904	EE76	9T83B3425G13	\$35730.00

K=4 80°C Rise

Input Voltage	Output Voltage	kVA	Taps	Wiring Diagram No. ¹	Approx. Net Weight (Lbs)	Frame Size	Product Number	List Price GO-67D
480	208Y/120	15	(+2,-4 2.5%)	12	375	EE72	9T83B3421G83	\$10621.00
480	208Y/120	30	(+2,-4 2.3%)	12	430	EE73	9T83B3422G83	\$11334.00
480	208Y/120	75	(+2,-4 2.5%)	12	904	EE76	9T83B3424G83	\$35958.00

K=13 150°C Rise

Input Voltage	Output Voltage	kVA	Taps	Wiring Diagram No. ¹	Approx. Net Weight (Lbs)	Frame Size	Product Number	List Price GO-67D
480	208Y/120	15	(+2,-4 2.6%)	12	265	EE71	9T83B3431G03	\$10507.00
480	208Y/120	30	(+2,-4 2.5%)	12	375	EE72	9T83B3432G03	\$10735.00
480	208Y/120	45	(+2,-4 2.3%)	12	430	EE73	9T83B3433G03	\$15580.00
480	208Y/120	75	(+2,-4 2.6%)	12	760	EE75	9T83B3434G03	\$16378.00
480	208Y/120	112.5	(+2,-4 2.5%)	12	904	EE76	9T83B3435G03	\$36376.00

K=13 115°C Rise

Input Voltage	Output Voltage	kVA	Taps	Wiring Diagram No. ¹	Approx. Net Weight (Lbs)	Frame Size	Product Number	List Price GO-67D
480	208Y/120	15	(+2,-4 2.5%)	12	375	EE72	9T83B3431G13	\$10773.00
480	208Y/120	30	(+2,-4 2.3%)	12	430	EE73	9T83B3432G13	\$11495.00
480	208Y/120	75	(+2,-4 2.6%)	12	760	EE75	9T83B3434G13	\$18772.00

K=13 80°C Rise

Input Voltage	Output Voltage	kVA	Taps	Wiring Diagram No. ¹	Approx. Net Weight (Lbs)	Frame Size	Product Number	List Price GO-67D
480	208Y/120	15	(+2,-4 2.5%)	12	375	EE72	9T83B3431G83	\$10821.00
480	208Y/120	30	(+2,-4 2.3%)	12	430	EE73	9T83B3432G83	\$15713.00

¹See page 8-44 for wiring diagrams.



Publications and Reference: See Section 22 for a complete list of additional product-related publications

Transformers

K-Factor Low Noise

Aluminum

Three-Phase TP-1

Section 8

K=20 150°C Rise

Input Voltage	Output Voltage	kVA	Taps	Wiring Diagram No. ¹	Approx. Net Weight (Lbs)	Frame Size	Product Number	List Price GO-67D
480	208Y/120	15	(+2,-4 2.6%)	12	265	EE71	9T83B3441G03	\$10621.00
480	208Y/120	30	(+2,-4 2.3%)	12	430	EE73	9T83B3442G03	\$10802.00
480	208Y/120	45	(+2,-4 2.3%)	12	430	EE73	9T83B3443G03	\$15694.00
480	208Y/120	75	(+2,-4 2.6%)	12	760	EE75	9T83B3444G03	\$16625.00

K=20 115°C Rise

Input Voltage	Output Voltage	kVA	Taps	Wiring Diagram No. ¹	Approx. Net Weight (Lbs)	Frame Size	Product Number	List Price GO-67D
480	208Y/120	15	(+2,-4 2.5%)	12	375	EE72	9T83B3441G13	\$10840.00
480	208Y/120	30	(+2,-4 2.3%)	12	430	EE73	9T83B3442G13	\$11581.00
480	208Y/120	75	(+2,-4 2.5%)	12	904	EE76	9T83B3444G13	\$36775.00

K=20 80°C Rise

Input Voltage	Output Voltage	kVA	Taps	Wiring Diagram No. ¹	Approx. Net Weight (Lbs)	Frame Size	Product Number	List Price GO-67D
480	208Y/120	15	(+2,-4 2.5%)	12	375	EE72	9T83B3441G83	\$10906.00

K=30 150°C Rise

Input Voltage	Output Voltage	kVA	Taps	Wiring Diagram No. ¹	Approx. Net Weight (Lbs)	Frame Size	Product Number	List Price GO-67D
480	208Y/120	15	(+2,-4 2.6%)	12	265	EE71	9T83B3451G03	\$10840.00
480	208Y/120	30	(+2,-4 2.3%)	12	430	EE73	9T83B3452G03	\$11030.00
480	208Y/120	75	(+2,-4 2.6%)	12	760	EE75	9T83B3454G03	\$17338.00

K=30 115°C Rise

Input Voltage	Output Voltage	kVA	Taps	Wiring Diagram No. ¹	Approx. Net Weight (Lbs)	Frame Size	Product Number	List Price GO-67D
480	208Y/120	15	(+2,-4 2.5%)	12	375	EE72	9T83B3451G13	\$11068.00
480	208Y/120	30	(+2,-4 2.3%)	12	430	EE73	9T83B3452G13	\$11818.00
480	208Y/120	75	(+2,-4 2.5%)	12	904	EE76	9T83B3454G13	\$37601.00

K-Factor Low-Noise Aluminum Three-Phase K=30 80°C Rise

Input Voltage	Output Voltage	kVA	Taps	Wiring Diagram No. ¹	Approx. Net Weight (Lbs)	Frame Size	Product Number	List Price GO-67D
480	208Y/120	15	(+2,-4 2.5%)	12	375	EE72	9T83B3451G83	\$11172.00

¹See page 8-44 for wiring diagrams.



Transformers

K-Factor Low Noise

Copper

Three-Phase TP-1

K = 4 150°C Rise

Input Voltage	Output Voltage	kVA	Taps	Wiring Diagram No. ¹	Approx. Net Weight (Lbs)	Frame Size	Product Number	List Price GO-67D
480	208Y/120	15	(+2,-4 2.6%)	12	290	EE71	9T83C9421G03	\$12721.00
480	208Y/120	30	(+2,-4 2.5%)	12	435	EE72	9T83C9422G03	\$15229.00
480	208Y/120	45	(+2,-4 2.3%)	12	510	EE73	9T83C9423G03	\$18069.00
480	208Y/120	75	(+2,-4 2.4%)	12	730	EE74	9T83C9424G03	\$26420.00
480	208Y/120	112.5	(+2,-4 2.4%)	12	965	EE76	9T83C9425G03	\$48849.00

K = 4 115°C Rise

Input Voltage	Output Voltage	kVA	Taps	Wiring Diagram No. ¹	Approx. Net Weight (Lbs)	Frame Size	Product Number	List Price GO-67D
480	208Y/120	15	(+2,-4 2.5%)	12	435	EE72	9T83C9421G13	\$12759.00
480	208Y/120	30	(+2,-4 2.3%)	12	510	EE73	9T83C9422G13	\$18136.00
480	208Y/120	75	(+2,-4 2.6%)	12	820	EE75	9T83C9424G13	\$34010.00
480	208Y/120	112.5	(+2,-4 2.5%)	12	965	EE76	9T83C9425G13	\$49020.00

K = 4 80°C Rise

Input Voltage	Output Voltage	kVA	Taps	Wiring Diagram No. ¹	Approx. Net Weight (Lbs)	Frame Size	Product Number	List Price GO-67D
480	208Y/120	15	(+2,-4 2.5%)	12	435	EE72	9T83C9421G83	\$15381.00
480	208Y/120	30	(+2,-4 2.3%)	12	510	EE73	9T83C9422G83	\$18250.00
480	208Y/120	75	(+2,-4 2.4%)	12	965	EE76	9T83C9424G83	\$34229.00

K = 13 150°C Rise

Input Voltage	Output Voltage	kVA	Taps	Wiring Diagram No. ¹	Approx. Net Weight (Lbs)	Frame Size	Product Number	List Price GO-67D
480	208Y/120	15	(+2,-4 2.6%)	12	290	EE71	9T83C9431G03	\$12806.00
480	208Y/120	30	(+2,-4 2.5%)	12	435	EE72	9T83C9432G03	\$15333.00
480	208Y/120	75	(+2,-4 2.6%)	12	820	EE75	9T83C9434G03	\$27569.00
480	208Y/120	112.5	(+2,-4 2.4%)	12	965	EE76	9T83C9435G03	\$49201.00

K = 13 115°C Rise

Input Voltage	Output Voltage	kVA	Taps	Wiring Diagram No. ¹	Approx. Net Weight (Lbs)	Frame Size	Product Number	List Price GO-67D
480	208Y/120	15	(+2,-4 2.5%)	12	435	EE72	9T83C9431G13	\$15599.00
480	208Y/120	30	(+2,-4 2.3%)	12	510	EE73	9T83C9432G13	\$18516.00
480	208Y/120	75	(+2,-4 2.6%)	12	820	EE75	9T83C9434G13	\$34742.00

K = 13 80°C Rise

Input Voltage	Output Voltage	kVA	Taps	Wiring Diagram No. ¹	Approx. Net Weight (Lbs)	Frame Size	Product Number	List Price GO-67D
480	208Y/120	15	(+2,-4 2.5%)	12	435	EE72	9T83C9431G83	\$15675.00
480	208Y/120	30	(+2,-4 2.3%)	12	510	EE73	9T83C9432G83	\$18611.00

¹See page 8-44 for wiring diagrams.



Publications and Reference: See Section 22 for a complete list of additional product-related publications

Transformers

K-Factor Low Noise

Copper

Three-Phase TP-1

Section 8

K = 20 150°C Rise

Input Voltage	Output Voltage	kVA	Taps	Wiring Diagram No. ¹	Approx. Net Weight (Lbs)	Frame Size	Product Number	List Price GO-67D
480	208Y/120	15	(+2,-4 2.6%)	12	290	EE71	9T83C9441G03	\$13072.00
480	208Y/120	30	(+2,-4 2.3%)	12	510	EE73	9T83C9442G03	\$15656.00
480	208Y/120	75	(+2,-4 2.6%)	12	820	EE75	9T83C9444G03	\$28405.00

K = 20 115°C Rise

Input Voltage	Output Voltage	kVA	Taps	Wiring Diagram No. ¹	Approx. Net Weight (Lbs)	Frame Size	Product Number	List Price GO-67D
480	208Y/120	15	(+2,-4 2.5%)	12	435	EE72	9T83C9441G13	\$15713.00
480	208Y/120	30	(+2,-4 2.3%)	12	510	EE73	9T83C9442G13	\$18649.00
480	208Y/120	75	(+2,-4 2.5%)	12	965	EE76	9T83C9444G13	\$50464.00

K = 20 80°C Rise

Input Voltage	Output Voltage	kVA	Taps	Wiring Diagram No. ¹	Approx. Net Weight (Lbs)	Frame Size	Product Number	List Price GO-67D
480	208Y/120	15	(+2,-4 2.5%)	12	435	EE72	9T83C9441G83	\$15808.00

K = 30 150°C Rise

Input Voltage	Output Voltage	kVA	Taps	Wiring Diagram No. ¹	Approx. Net Weight (Lbs)	Frame Size	Product Number	List Price GO-67D
480	208Y/120	15	(+2,-4 2.6%)	12	290	EE71	9T83C9451G03	\$15989.00
480	208Y/120	30	(+2,-4 2.3%)	12	510	EE73	9T83C9452G03	\$16407.00
480	208Y/120	75	(+2,-4 2.6%)	12	820	EE75	9T83C9454G03	\$28956.00

K = 30 115°C Rise

Input Voltage	Output Voltage	kVA	Taps	Wiring Diagram No. ¹	Approx. Net Weight (Lbs)	Frame Size	Product Number	List Price GO-67D
480	208Y/120	15	(+2,-4 2.5%)	12	435	EE72	9T83C9451G13	\$16055.00
480	208Y/120	30	(+2,-4 2.3%)	12	510	EE73	9T83C9452G13	\$19057.00
480	208Y/120	75	(+2,-4 2.5%)	12	965	EE76	9T83C9454G13	\$51595.00

K = 30 80°C Rise

Input Voltage	Output Voltage	kVA	Taps	Wiring Diagram No. ¹	Approx. Net Weight (Lbs)	Frame Size	Product Number	List Price GO-67D
480	208Y/120	15	(+2,-4 2.5%)	12	435	EE72	9T83C9451G83	\$16207.00

¹See page 8-44 for wiring diagrams.



Transformers

Low Noise

Aluminum

Three-Phase TP-1

Product Description

These low noise transformers are designed to operate at reduced noise levels. The vibrations within the magnetic steel core were greatly reduced, thus lowering the humming of the transformer to 3 to 5 dB less than NEMA/ANSI standards. Available in Aluminum or Copper windings, they feature a 220°C insulation system with either a 150°C, 115°C or 80°C rise.

Application

Type QL low noise transformers are ideal when quiet operation is required such as near offices, in school buildings, or hospitals. Although they are inherently quieter, installation can greatly influence their noise level and therefore care should be taken in following acoustical principles as well as proper installation procedures. Closets and corners should be avoided as they act as megaphones by seemingly increasing noise levels.



Type QL Low Noise Transformer (front panel removed)

150°C Rise NEMA 2

Input Voltage	Output Voltage	kVA	Approximate Sound Level (dB)	Taps	Wiring Diagram No. ¹	Approx. Net Weight (Lbs.)	Frame Size	Product Number	List Price	GO Schedule
480 Volts Delta	208Y/120 Volts	15	40	(+2,-4 2.6%)	12	265	EE71	9T83B3141	\$6108.00	66K
480 Volts Delta	208Y/120 Volts	30	40	(+2,-4 2.5%)	12	375	EE72	9T83B3142	\$7270.00	66K
480 Volts Delta	208Y/120 Volts	45	40	(+2,-4 2.3%)	12	430	EE73	9T83B3143	\$7883.00	66K
480 Volts Delta	208Y/120 Volts	75	45	(+2,-4 2.4%)	12	600	EE74	9T83B3144	\$10138.00	66K
480 Volts Delta	208Y/120 Volts	112.5	45	(+2,-4 2.6%)	12	760	EE75	9T83B3145	\$13204.00	66K
480 Volts Delta	208Y/120 Volts	150	45	(+2,-4 2.5%)	12	1585	EE76	9T83B3146	\$17921.00	66K
480 Volts Delta	208Y/120 Volts	225						9T83B3147	\$32050.32	67AG
480 Volts Delta	208Y/120 Volts	300						9T83B3148	\$49410.34	67AG

115°C Rise NEMA 2

Input Voltage	Output Voltage	kVA	Approximate Sound Level (dB)	Taps	Wiring Diagram No. ¹	Approx. Net Weight (Lbs.)	Frame Size	Product Number	List Price	GO Schedule
480 Volts Delta	208Y/120 Volts	15	40	(+2,-4 2.6%)	12	265	EE71	9T83B3141G15	\$6180.00	66K
480 Volts Delta	208Y/120 Volts	30	40	(+2,-4 2.5%)	12	375	EE72	9T83B3142G15	\$7570.00	66K
480 Volts Delta	208Y/120 Volts	45	40	(+2,-4 2.3%)	12	430	EE73	9T83B3143G15	\$9507.00	66K
480 Volts Delta	208Y/120 Volts	75	45	(+2,-4 2.4%)	12	600	EE74	9T83B3144G15	\$11058.00	66K
480 Volts Delta	208Y/120 Volts	112.5	45	(+2,-4 2.6%)	12	760	EE75	9T83B3145G15	\$19139.00	67A
480 Volts Delta	208Y/120 Volts	150						9T83B3146G15	\$28264.34	67A
480 Volts Delta	208Y/120 Volts	225						9T83B3147G15	\$57504.00	67AG
480 Volts Delta	208Y/120 Volts	300						9T83B3148G15	\$57645.39	67A

80°C Rise NEMA 2

Input Voltage	Output Voltage	kVA	Approximate Sound Level (dB)	Taps	Wiring Diagram No. ¹	Approx. Net Weight (Lbs.)	Frame Size	Product Number	List Price	GO Schedule
480 Volts Delta	208Y/120 Volts	15	40	(+2,-4 2.6%)	12	265	EE71	9T83B3141G80	\$5920.00	67A
480 Volts Delta	208Y/120 Volts	30	40	(+2,-4 2.3%)	12	430	EE73	9T83B3142G80	\$8179.00	66K
480 Volts Delta	208Y/120 Volts	45	40	(+2,-4 2.4%)	12	600	EE74	9T83B3143G80	\$11379.00	67A
480 Volts Delta	208Y/120 Volts	75	40	(+2,-4 2.3%)	12	760	EE75	9T83B3144G80	\$16298.00	67A
480 Volts Delta	208Y/120 Volts	112.5						9T83B3145G80	\$21873.00	66K
480 Volts Delta	208Y/120 Volts	150						9T83B3146G80	\$28264.00	66KG
480 Volts Delta	208Y/120 Volts	225						9T83B3147G80	\$46294.91	67AG
480 Volts Delta	208Y/120 Volts	300						9T83B3148G80	\$64233.44	67AG

¹See page 8-44 for wiring diagrams.



Publications and Reference: See Section 22 for a complete list of additional product-related publications

Transformers

Low Noise

Copper

Three-Phase TP-1

Section 8

150°C Rise NEMA 2

Input Voltage	Output Voltage	kVA	Approximate Sound Level (dB)	Taps	Wiring Diagram No. ¹	Approx. Net Weight (Lbs.)	Frame Size	Product Number	List Price	GO Schedule
480 Volts Delta	208Y/120 Volts	15	40	(+2,-4 2.6%)	12	290	EE71	9T83C9141	\$7019.00	67AC
480 Volts Delta	208Y/120 Volts	30	40	(+2,-4 2.5%)	12	435	EE72	9T83C9142	\$9424.00	66KC
480 Volts Delta	208Y/120 Volts	45	40	(+2,-4 2.3%)	12	510	EE73	9T83C9143	\$10253.00	66KC
480 Volts Delta	208Y/120 Volts	75	45	(+2,-4 2.4%)	12	730	EE74	9T83C9144	\$16154.00	66KC
480 Volts Delta	208Y/120 Volts	112.5	45	(+2,-4 2.6%)	12	820	EE75	9T83C9145	\$18575.00	66KC
480 Volts Delta	208Y/120 Volts	150	45	(+2,-4 2.4%)	12	1700	EE76	9T83C9146	\$28264.00	67AC
480 Volts Delta	208Y/120 Volts	225						9T83C9147	\$36160.00	66KC
480 Volts Delta	208Y/120 Volts	300						9T83C9148	\$64233.44	67AGC

115°C Rise NEMA 2

Input Voltage	Output Voltage	kVA	Approximate Sound Level (dB)	Taps	Wiring Diagram No. ¹	Approx. Net Weight (Lbs.)	Frame Size	Product Number	List Price	GO Schedule
480 Volts Delta	208Y/120 Volts	15	40	(+2,-4 2.6%)	12	290	EE71	9T83C9141G15	\$8380.00	66KC
480 Volts Delta	208Y/120 Volts	30	40	(+2,-4 2.5%)	12	435	EE72	9T83C9142G15	\$12065.00	66KC
480 Volts Delta	208Y/120 Volts	45	40	(+2,-4 2.3%)	12	510	EE73	9T83C9143G15	\$15105.00	66KC
480 Volts Delta	208Y/120 Volts	75	45	(+2,-4 2.4%)	12	730	EE74	9T83C9144G15	\$20748.00	66KC
480 Volts Delta	208Y/120 Volts	112.5	45	(+2,-4 2.6%)	12	820	EE75	9T83C9145G15	\$24396.00	66KC
480 Volts Delta	208Y/120 Volts	150						9T83C9146G15	\$35796.00	66KC
480 Volts Delta	208Y/120 Volts	225						9T83C9147G15	\$35435.00	66KC
480 Volts Delta	208Y/120 Volts	300						9T83C9148G15	\$108425.00	67AC

80°C Rise NEMA 2

Input Voltage	Output Voltage	kVA	Approximate Sound Level (dB)	Taps	Wiring Diagram No. ¹	Approx. Net Weight (Lbs.)	Frame Size	Product Number	List Price	GO Schedule
480 Volts Delta	208Y/120 Volts	15	40	(+2,-4 2.5%)	12	435	EE72	9T83C9141G80	\$9215.00	67AC
480 Volts Delta	208Y/120 Volts	30	40	(+2,-4 2.3%)	12	510	EE73	9T83C9142G80	\$11991.44	67AC
480 Volts Delta	208Y/120 Volts	45	40	(+2,-4 2.4%)	12	730	EE74	9T83C9143G80	\$14940.00	67AC
480 Volts Delta	208Y/120 Volts	75	40	(+2,-4 2.6%)	12	820	EE75	9T83C9144G80	\$20882.00	66KC
480 Volts Delta	208Y/120 Volts	112.5						9T83C9145G80	\$37700.00	67AC
480 Volts Delta	208Y/120 Volts	150						9T83C9146G80	\$55250.00	66KGC
480 Volts Delta	208Y/120 Volts	225						9T83C9147G80	\$71022.00	66KC
480 Volts Delta	208Y/120 Volts	300						9T83C9148G80	\$111855.00	67AGC

¹See page 8-44 for wiring diagrams.



Transformers Noise Isolation – Guard I Aluminum Three-Phase TP-1

150°C Rise

Primary Voltage	Secondary Voltage	kVA	Taps	Net Weight (Lbs.)	Frame Size	Product Number	List Price	GO Schedule
480	208Y/120	15	(+2,-4 2.6%)	265	EE71	9T83B3871G03	\$4157.00	66K
480	208Y/120	30	(+2,-4 2.5%)	375	EE72	9T83B3872G03	\$6745.00	66K
480	208Y/120	45	(+2,-4 2.3%)	430	EE73	9T83B3873G03	\$7210.00	66K
480	208Y/120	75	(+2,-4 2.4%)	600	EE74	9T83B3874G03	\$9090.00	66K
480	208Y/120	112.5	(+2,-4 2.6%)	760	EE75	9T83B3875G03	\$10473.00	66K
480	208Y/120	150	(+2,-4 2.4%)	904	EE76	9T83B3876G03	\$13209.00	66K
480	208Y/120	225	(+2,-4 2.6%)	1585	EE77	9T83B3877G03	\$30863.00	67E
480	208Y/120	300	(+2,-4 2.6%)	1020	FC78	9T40G0008G03	\$37881.00	67E
480	208Y/120	500	(+2,-4 1.8%)	1585	FC79	9T40G0009G03	\$40070.00	66KG
480	208Y/120	750	(+2,-4 2.5%)	3250	FC67	9T40G0010G03	\$101105.00	67E
480	208Y/120	1000	(+2,-4 2.5%)	3250	FC68	9T40G0011G03	\$104345.00	67E

115°C Rise

Primary Voltage	Secondary Voltage	kVA	Taps	Net Weight (Lbs.)	Frame Size	Product Number	List Price	GO Schedule
480	208Y/120	15	(+2,-4 2.6%)	265	EE71	9T83B3871G13	\$7800.00	66K
480	208Y/120	30	(+2,-4 2.5%)	375	EE72	9T83B3872G13	\$8311.00	66K
480	208Y/120	45	(+2,-4 2.3%)	430	EE73	9T83B3873G13	\$9581.00	66K
480	208Y/120	75	(+2,-4 2.4%)	600	EE74	9T83B3874G13	\$11214.00	66K
480	208Y/120	112.5	(+2,-4 2.5%)	760	EE76	9T83B3875G13	\$13415.00	66K
480	208Y/120	150	(+2,-4 2.6%)	1585	EE77	9T83B3876G13	\$27381.00	66K
480	208Y/120	225	(+2,-4 2.6%)	1020	FC78	9T40G0007G53	\$29149.00	66KG
480	208Y/120	300	(+2,-4 1.8%)	1585	FC79	9T40G0008G53	\$46116.00	67AG
480	208Y/120	500	(+2,-4 2.5%)	3250	FC67	9T40G0009G53	\$80365.00	67E

80°C Rise

Primary Voltage	Secondary Voltage	kVA	Taps	Net Weight (Lbs.)	Frame Size	Product Number	List Price	GO Schedule
480	208Y/120	15	(+2,-4 2.6%)	265	EE71	9T83B3871G83	\$7019.00	67E
480	208Y/120	30	(+2,-4 2.3%)	430	EE73	9T83B3872G83	\$9136.00	67E
480	208Y/120	45	(+2,-4 2.4%)	600	EE74	9T83B3873G83	\$11380.00	67E
480	208Y/120	75	(+2,-4 2.6%)	760	EE75	9T83B3874G83	\$16298.00	67E
480	208Y/120	112.5	(+2,-4 2.6%)	1585	EE77	9T83B3875G83	\$23923.00	67E
480	208Y/120	150	(+2,-4 2.4%)	845	FC77	9T40G0006G83	\$28264.00	67E
480	208Y/120	225	(+2,-4 2.6%)	1020	FC78	9T40G0007G83	\$37986.00	67E
480	208Y/120	300	(+2,-4 1.8%)	1585	FC79	9T40G0008G83	\$52704.00	67E



Publications and Reference: See Section 22 for a complete list of additional product-related publications

Transformers

Noise Isolation – Guard I

Copper

Three-Phase TP-1

Section 8

150°C Rise

Primary Voltage	Secondary Voltage	kVA	Taps	Net Weight (Lbs.)	Frame Size	Product Number	List Price	GO Schedule
480	208Y/120	15	(+2,-4 2.6%)	290	EE71	9T83C9871G03	\$7677.00	67AC
480	208Y/120	30	(+2,-4 2.5%)	435	EE72	9T83C9872G03	\$8398.00	66KC
480	208Y/120	45	(+2,-4 2.3%)	510	EE73	9T83C9873G03	\$10355.00	66KC
480	208Y/120	75	(+2,-4 2.4%)	730	EE74	9T83C9874G03	\$13395.00	66KC
480	208Y/120	112.5	(+2,-4 2.6%)	820	EE75	9T83C9875G03	\$23923.00	67AC
480	208Y/120	150	(+2,-4 2.4%)	965	EE76	9T83C9876G03	\$30914.00	67AC
480	208Y/120	225	(+2,-4 2.5%)	1700	EE77	9T83C9877G03	\$41547.00	67AC
480	208Y/120	300	(+2,-4 2.6%)	1160	FC78	9T45G0008G03	\$42659.00	66KGC
480	208Y/120	500	(+2,-4 2.0%)	1700	FC79	9T45G0009G03	\$82958.00	67AGC
480	208Y/120	750	(+2,-4 2.5%)	4030	FC67	9T45G0010G03	\$136103.00	67AGC
480	208Y/120	1000	(+2,-4 2.5%)	4030	FC68	9T45G0011G03	\$158787.00	67AGC

115°C Rise

Primary Voltage	Secondary Voltage	kVA	Taps	Net Weight (Lbs.)	Frame Size	Product Number	List Price	GO Schedule
480	208Y/120	15	(+2,-4 2.6%)	290	EE71	9T83C9871G13	\$8774.00	67AC
480	208Y/120	30	(+2,-4 2.5%)	435	EE72	9T83C9872G13	\$11420.00	67AC
480	208Y/120	45	(+2,-4 2.3%)	510	EE73	9T83C9873G13	\$14224.00	67AC
480	208Y/120	75	(+2,-4 2.4%)	730	EE74	9T83C9874G13	\$19722.00	66KC
480	208Y/120	112.5	(+2,-4 2.6%)	820	EE75	9T83C9875G13	\$27341.00	67AC
480	208Y/120	150	(+2,-4 1.5%)	965	EE77	9T83C9876G13	\$35330.00	67AC
480	208Y/120	225	(+2,-4 2.6%)	1160	FC78	9T45G0007G53	\$47482.00	66KGC
480	208Y/120	300	(+2,-4 2.0%)	1700	FC79	9T45G0008G53	\$65880.00	66KGC

80°C Rise

Primary Voltage	Secondary Voltage	kVA	Taps	Net Weight (Lbs.)	Frame Size	Product Number	List Price	GO Schedule
480	208Y/120	15	(+2,-4 2.5%)	435	EE72	9T83C9871G83	\$9651.00	67AC
480	208Y/120	30	(+2,-4 2.3%)	510	EE73	9T83C9872G83	\$12562.00	67AC
480	208Y/120	45	(+2,-4 2.4%)	730	EE74	9T83C9873G83	\$15647.00	67AC
480	208Y/120	75	(+2,-4 2.6%)	820	EE75	9T83C9874G83	\$22410.00	67AC
480	208Y/120	112.5	(+2,-4 2.5%)	820	EE75	9T83C9875G83	\$36670.00	67AC
480	208Y/120	150	(+2,-4 2.4%)	976	FC77	9T45G0006G83	\$42400.00	67AGC
480	208Y/120	225	(+2,-4 2.6%)	1160	FC78	9T45G0007G83	\$48669.00	67AGC
480	208Y/120	300	(+2,-4 2.0%)	1700	FC79	9T45G0008G83	\$67527.00	67AGC
480	208Y/120	500	(+2,-4 2.5%)	4030	FC67	9T45G0009G83	\$114067.00	67AGC



Transformers

Noise Isolation – Guard II

Guard II noise isolation transformers provide common mode noise attenuation plus an enhanced level of transverse mode noise attenuation for increased protection of sensitive electronic equipment.

Key Features

- Grounded copper electrostatic shield between primary and secondary windings
- Noise suppressors and spike/surge suppressors
- 120dB common mode noise rejection
- 60dB transverse mode noise rejection
- Single and three-phase ratings
- Compliance with ANSI and NEMA standards
- TP-1 sound levels below ANSI limits
- 220°C insulation system
- UL Listed
- NEMA 2 enclosure

Applications

- Schools and colleges
- Large computer installations
- Small commercial offices
- Motor installations
- Process controllers
- Hospitals
- X-ray rooms
- Electrical laboratories
- High lightning strike areas



Guard II Transformer



Guard II Transformer, (front panel removed)



Transformers

Noise Isolation – Guard II

Aluminum

Three-Phase TP-1

Section 8

150°C Rise

Primary Voltage	Secondary Voltage	kVA	Taps	Net Weight (Lbs.)	Frame Size	Product Number	List Price GO-67E
480	208Y/120	15	(+2,-4 2.6%)	265	EE71	9T86B3871G03	\$10968.00
480	208Y/120	30	(+2,-4 2.5%)	375	EE72	9T86B3872G03	\$13419.00
480	208Y/120	45	(+2,-4 2.3%)	430	EE73	9T86B3873G03	\$16714.00
480	208Y/120	75	(+2,-4 2.4%)	600	EE74	9T86B3874G03	\$23938.00
480	208Y/120	112.5	(+2,-4 2.6%)	760	EE75	9T86B3875G03	\$34176.00

115°C Rise

Primary Voltage	Secondary Voltage	kVA	Taps	Net Weight (Lbs.)	Frame Size	Product Number	List Price GO-67E
480	208Y/120	15	(+2,-4 2.6%)	394	EE72	9T86B3871G13	\$12064.00
480	208Y/120	30	(+2,-4 2.5%)	375	EE72	9T86B3872G13	\$14847.00
480	208Y/120	45	(+2,-4 2.3%)	430	EE73	9T86B3873G13	\$19559.00
480	208Y/120	75	(+2,-4 2.4%)	600	EE74	9T86B3874G13	\$28013.00
480	208Y/120	112.5	(+2,-4 2.6%)	760	EE75	9T86B3875G13	\$37594.00

80°C Rise

Primary Voltage	Secondary Voltage	kVA	Taps	Net Weight (Lbs.)	Frame Size	Product Number	List Price GO-67E
480	208Y/120	15	(+2,-4 2.6%)	265	EE71	9T86B3871G83	\$12942.00
480	208Y/120	30	(+2,-4 2.3%)	430	EE73	9T86B3872G83	\$16845.00
480	208Y/120	45	(+2,-4 2.4%)	600	EE74	9T86B3873G83	\$20981.00
480	208Y/120	75	(+2,-4 2.6%)	760	EE75	9T86B3874G83	\$30050.00

150°C Rise

Primary Voltage	Secondary Voltage	kVA	Taps	Net Weight (Lbs.)	Frame Size	Product Number	List Price GO-67E
208	208Y/120	15	(+2,-4 2.5%)	265	EE71	9T86B3091G03	\$10968.00
208	208Y/120	30	(+2,-4 2.6%)	375	EE72	9T86B3092G03	\$14276.00
208	208Y/120	45	(+2,-4 2.5%)	430	EE73	9T86B3093G03	\$17780.00
208	208Y/120	75	(+2,-4 2.7%)	600	EE74	9T86B3094G03	\$25466.00
208	208Y/120	112.5	(+2,-4 2.2%)	760	EE75	9T86B3095G03	\$34176.00

115°C Rise

Primary Voltage	Secondary Voltage	kVA	Taps	Net Weight (Lbs.)	Frame Size	Product Number	List Price GO-67E
208	208Y/120	15	(+2,-4 2.5%)	265	EE71	9T86B3091G13	\$12064.00
208	208Y/120	30	(+2,-4 2.6%)	435	EE72	9T86B3092G13	\$14847.00
208	208Y/120	45	(+2,-4 2.5%)	430	EE73	9T86B3093G13	\$19559.00
208	208Y/120	75	(+2,-4 2.7%)	600	EE74	9T86B3094G13	\$28013.00
208	208Y/120	112.5	(+2,-4 2.2%)	760	EE75	9T86B3095G13	\$37594.00

80°C Rise

Primary Voltage	Secondary Voltage	kVA	Taps	Net Weight (Lbs.)	Frame Size	Product Number	List Price GO-67E
208	208Y/120	15	(+2,-4 2.5%)	265	EE71	9T86B3091G83	\$12942.00
208	208Y/120	30	(+2,-4 2.5%)	430	EE73	9T86B3092G83	\$16845.00
208	208Y/120	45	(+2,-4 2.7%)	600	EE74	9T86B3093G83	\$20981.00
208	208Y/120	75	(+2,-4 2.2%)	760	EE75	9T86B3094G83	\$30050.00



Transformers

Noise Isolation – Guard II

Copper

Three-Phase TP-1

150°C Rise

Primary Voltage	Secondary Voltage	kVA	Taps	Net Weight (Lbs.)	Frame Size	Product Number	List Price GO-67E
480	208Y/120	15	(+2,-4 2.6%)	265	EE71	9T86C9871G03	\$12942.00
480	208Y/120	30	(+2,-4 2.5%)	435	EE72	9T86C9872G03	\$15989.00
480	208Y/120	45	(+2,-4 2.3%)	430	EE73	9T86C9873G03	\$20981.00
480	208Y/120	75	(+2,-4 2.4%)	730	EE74	9T86C9874G03	\$30050.00
480	208Y/120	112.5	(+2,-4 2.6%)	820	EE75	9T86C9875G03	\$40328.00

115°C Rise

Primary Voltage	Secondary Voltage	kVA	Taps	Net Weight (Lbs.)	Frame Size	Product Number	List Price GO-67E
480	208Y/120	9	(+2,-4 2.6%)	265	EE71	9T86C9870G13	\$16846.00
480	208Y/120	15	(+2,-4 2.6%)	265	EE71	9T86C9871G13	\$14038.00
480	208Y/120	30	(+2,-4 2.5%)	435	EE72	9T86C9872G13	\$18273.00
480	208Y/120	45	(+2,-4 2.3%)	430	EE73	9T86C9873G13	\$22759.00
480	208Y/120	75	(+2,-4 2.4%)	730	EE74	9T86C9874G13	\$32596.00
480	208Y/120	112.5	(+2,-4 2.6%)	730	EE74	9T86C9875G13	\$43745.00

80°C Rise

Primary Voltage	Secondary Voltage	kVA	Taps	Net Weight (Lbs.)	Frame Size	Product Number	List Price GO-67E
480	208Y/120	15	(+2,-4 2.6%)	435	EE72	9T86C9871G83	\$14916.00
480	208Y/120	30	(+2,-4 2.3%)	430	EE73	9T86C9872G83	\$19415.00
480	208Y/120	45	(+2,-4 2.4%)	730	EE74	9T86B9873G83	\$24181.00
480	208Y/120	75	(+2,-4 2.6%)	820	EE75	9T86C9874G83	\$34634.00

150°C Rise

Primary Voltage	Secondary Voltage	kVA	Taps	Net Weight (Lbs.)	Frame Size	Product Number	List Price GO-67E
208	208Y/120	15	(+2,-4 2.5%)	265	EE71	9T86C9091G03	\$12942.00
208	208Y/120	30	(+2,-4 2.5%)	435	EE72	9T86C9092G03	\$16845.00
208	208Y/120	45	(+2,-4 2.5%)	430	EE73	9T86C9093G03	\$20981.00
208	208Y/120	75	(+2,-4 2.7%)	730	EE74	9T86C9094G03	\$30050.00
208	208Y/120	112.5	(+2,-4 2.2%)	820	EE75	9T86C9095G03	\$40328.00

115°C Rise

Primary Voltage	Secondary Voltage	kVA	Taps	Net Weight (Lbs.)	Frame Size	Product Number	List Price GO-67E
208	208Y/120	15	(+2,-4 2.7%)	290	EE71	9T86C9091G13	\$13380.00
208	208Y/120	30	(+2,-4 2.6%)	435	EE72	9T86C9092G13	\$18273.00
208	208Y/120	45	(+2,-4 2.5%)	430	EE73	9T86C9093G13	\$22759.00
208	208Y/120	75	(+2,-4 2.7%)	730	EE74	9T86C9094G13	\$32596.00
208	208Y/120	112.5	(+2,-4 2.2%)	820	EE75	9T86C9095G13	\$43745.00



Publications and Reference: See Section 22 for a complete list of additional product-related publications

Transformers

Harmonic Mitigating – Guard III

Copper

Three-Phase TP-1

Section 8

0° Phase Shift NEMA 3R

Input Voltage	Output Voltage	kVA	Approx. Net Weight (Lbs.)	Product Number	List Price GO-67E
208 Volts Delta	208V/120 Volts	15	220	9T96C9091G03	\$27200.00
208 Volts Delta	208V/120 Volts	30	360	9T96C9092G03	\$30104.00
208 Volts Delta	208V/120 Volts	45	465	9T96C9093G03	\$39032.00
208 Volts Delta	208V/120 Volts	75	740	9T96C9094G03	\$54400.00
208 Volts Delta	208V/120 Volts	112.5	985	9T96C9095G03	\$76800.00
208 Volts Delta	208V/120 Volts	150	1200	9T96C9096G03	\$88200.00
208 Volts Delta	208V/120 Volts	225	1800	9T96C9097G03	\$152000.00
208 Volts Delta	208V/120 Volts	300	2400	9T96C9098G03	\$176000.00
208 Volts Delta	208V/120 Volts	500	3200	9T96C9099G03	\$280000.00
208 Volts Delta	480V/277 Volts	15	220	9T96C9801G03	\$27200.00
208 Volts Delta	480V/277 Volts	30	360	9T96C9802G03	\$30104.00
208 Volts Delta	480V/277 Volts	45	465	9T96C9803G03	\$39032.00
208 Volts Delta	480V/277 Volts	75	740	9T96C9804G03	\$54400.00
208 Volts Delta	480V/277 Volts	112.5	985	9T96C9805G03	\$76800.00
208 Volts Delta	480V/277 Volts	150	1200	9T96C9806G03	\$88200.00
208 Volts Delta	480V/277 Volts	225	1800	9T96C9807G03	\$152000.00
208 Volts Delta	480V/277 Volts	300	2400	9T96C9808G03	\$176000.00
208 Volts Delta	480V/277 Volts	500	3200	9T96C9809G03	\$280000.00
480 Volts Delta	208V/120 Volts	15	220	9T96C9871G03	\$22666.00
480 Volts Delta	208V/120 Volts	30	360	9T96C9872G03	\$25086.00
480 Volts Delta	208V/120 Volts	45	465	9T96C9873G03	\$32526.00
480 Volts Delta	208V/120 Volts	75	740	9T96C9874G03	\$45333.00
480 Volts Delta	208V/120 Volts	112.5	985	9T96C9875G03	\$64000.00
480 Volts Delta	208V/120 Volts	150	1200	9T96C9876G03	\$73500.00
480 Volts Delta	208V/120 Volts	225	1800	9T96C9877G03	\$126666.00
480 Volts Delta	208V/120 Volts	300	2400	9T96C9878G03	\$146666.00
480 Volts Delta	208V/120 Volts	500	3200	9T96C9879G03	\$233333.00
480 Volts Delta	480V/277 Volts	15	220	9T96C9851G03	\$27200.00
480 Volts Delta	480V/277 Volts	30	360	9T96C9852G03	\$30104.00
480 Volts Delta	480V/277 Volts	45	465	9T96C9853G03	\$39032.00
480 Volts Delta	480V/277 Volts	75	740	9T96C9854G03	\$54400.00
480 Volts Delta	480V/277 Volts	112.5	985	9T96C9855G03	\$76800.00
480 Volts Delta	480V/277 Volts	150	1200	9T96C9856G03	\$88200.00
480 Volts Delta	480V/277 Volts	225	1800	9T96C9857G03	\$152000.00
480 Volts Delta	480V/277 Volts	300	2400	9T96C9858G03	\$176000.00
480 Volts Delta	480V/277 Volts	500	3200	9T96C9859G03	\$280000.00
600 Volts Delta	208V/120 Volts	15	220	9T96C9891G03	\$22666.00
600 Volts Delta	208V/120 Volts	30	360	9T96C9892G03	\$25086.00
600 Volts Delta	208V/120 Volts	45	465	9T96C9893G03	\$32526.00
600 Volts Delta	208V/120 Volts	75	740	9T96C9894G03	\$45333.00
600 Volts Delta	208V/120 Volts	112.5	985	9T96C9895G03	\$64000.00
600 Volts Delta	208V/120 Volts	150	1200	9T96C9896G03	\$73500.00
600 Volts Delta	208V/120 Volts	225	1800	9T96C9897G03	\$126666.00
600 Volts Delta	208V/120 Volts	300	2400	9T96C9898G03	\$146666.00
600 Volts Delta	208V/120 Volts	500	3200	9T96C9899G03	\$233333.00
600 Volts Delta	480V/277 Volts	15	220	9T96C9631G03	\$27200.00
600 Volts Delta	480V/277 Volts	30	360	9T96C9632G03	\$30104.00
600 Volts Delta	480V/277 Volts	45	465	9T96C9633G03	\$39032.00
600 Volts Delta	480V/277 Volts	75	740	9T96C9634G03	\$54400.00
600 Volts Delta	480V/277 Volts	112.5	985	9T96C9635G03	\$76800.00
600 Volts Delta	480V/277 Volts	150	1200	9T96C9636G03	\$88200.00
600 Volts Delta	480V/277 Volts	225	1800	9T96C9637G03	\$152000.00
600 Volts Delta	480V/277 Volts	300	2400	9T96C9638G03	\$176000.00
600 Volts Delta	480V/277 Volts	500	3200	9T96C9639G03	\$280000.00



Transformers

Harmonic Mitigating – Guard III

Copper

Three-Phase TP-1

-30° Phase Shift NEMA 3R

Input Voltage	Output Voltage	kVA	Approx. Net Weight (Lbs.)	Product Number	List Price GO-67E
208 Volts Delta	208Y/120 Volts	15	220	9T97C9091G03	\$27200.00
208 Volts Delta	208Y/120 Volts	30	360	9T97C9092G03	\$30104.00
208 Volts Delta	208Y/120 Volts	45	465	9T97C9093G03	\$39032.00
208 Volts Delta	208Y/120 Volts	75	740	9T97C9094G03	\$54400.00
208 Volts Delta	208Y/120 Volts	112.5	985	9T97C9095G03	\$76800.00
208 Volts Delta	208Y/120 Volts	150	1200	9T97C9096G03	\$88200.00
208 Volts Delta	208Y/120 Volts	225	1800	9T97C9097G03	\$152000.00
208 Volts Delta	208Y/120 Volts	300	2400	9T97C9098G03	\$176000.00
208 Volts Delta	208Y/120 Volts	500	3200	9T97C9099G03	\$280000.00
208 Volts Delta	480Y/277 Volts	15	220	9T97C9801G03	\$27200.00
208 Volts Delta	480Y/277 Volts	30	360	9T97C9802G03	\$30104.00
208 Volts Delta	480Y/277 Volts	45	465	9T97C9803G03	\$39032.00
208 Volts Delta	480Y/277 Volts	75	740	9T97C9804G03	\$54400.00
208 Volts Delta	480Y/277 Volts	112.5	985	9T97C9805G03	\$76800.00
208 Volts Delta	480Y/277 Volts	150	1200	9T97C9806G03	\$88200.00
208 Volts Delta	480Y/277 Volts	225	1800	9T97C9807G03	\$152000.00
208 Volts Delta	480Y/277 Volts	300	2400	9T97C9808G03	\$176000.00
208 Volts Delta	480Y/277 Volts	500	3200	9T97C9809G03	\$280000.00
480 Volts Delta	208Y/120 Volts	15	220	9T97C9871G03	\$22666.00
480 Volts Delta	208Y/120 Volts	30	360	9T97C9872G03	\$25086.00
480 Volts Delta	208Y/120 Volts	45	465	9T97C9873G03	\$32526.00
480 Volts Delta	208Y/120 Volts	75	740	9T97C9874G03	\$45333.00
480 Volts Delta	208Y/120 Volts	112.5	985	9T97C9875G03	\$64000.00
480 Volts Delta	208Y/120 Volts	150	1200	9T97C9876G03	\$73500.00
480 Volts Delta	208Y/120 Volts	225	1800	9T97C9877G03	\$126666.00
480 Volts Delta	208Y/120 Volts	300	2400	9T97C9878G03	\$146666.00
480 Volts Delta	208Y/120 Volts	500	3200	9T97C9879G03	\$233333.00
480 Volts Delta	480Y/277 Volts	15	220	9T97C9851G03	\$27200.00
480 Volts Delta	480Y/277 Volts	30	360	9T97C9852G03	\$30104.00
480 Volts Delta	480Y/277 Volts	45	465	9T97C9853G03	\$39032.00
480 Volts Delta	480Y/277 Volts	75	740	9T97C9854G03	\$54400.00
480 Volts Delta	480Y/277 Volts	112.5	985	9T97C9855G03	\$76800.00
480 Volts Delta	480Y/277 Volts	150	1200	9T97C9856G03	\$88200.00
480 Volts Delta	480Y/277 Volts	225	1800	9T97C9857G03	\$152000.00
480 Volts Delta	480Y/277 Volts	300	2400	9T97C9858G03	\$176000.00
480 Volts Delta	480Y/277 Volts	500	3200	9T97C9859G03	\$280000.00
600 Volts Delta	208Y/120 Volts	15	220	9T97C9891G03	\$22666.00
600 Volts Delta	208Y/120 Volts	30	360	9T97C9892G03	\$25086.00
600 Volts Delta	208Y/120 Volts	45	465	9T97C9893G03	\$32526.00
600 Volts Delta	208Y/120 Volts	75	740	9T97C9894G03	\$45333.00
600 Volts Delta	208Y/120 Volts	112.5	985	9T97C9895G03	\$64000.00
600 Volts Delta	208Y/120 Volts	150	1200	9T97C9896G03	\$73500.00
600 Volts Delta	208Y/120 Volts	225	1800	9T97C9897G03	\$126666.00
600 Volts Delta	208Y/120 Volts	300	2400	9T97C9898G03	\$146666.00
600 Volts Delta	208Y/120 Volts	500	3200	9T97C9899G03	\$233333.00
600 Volts Delta	480Y/277 Volts	15	220	9T97C9631G03	\$27200.00
600 Volts Delta	480Y/277 Volts	30	360	9T97C9632G03	\$30104.00
600 Volts Delta	480Y/277 Volts	45	465	9T97C9633G03	\$39032.00
600 Volts Delta	480Y/277 Volts	75	740	9T97C9634G03	\$54400.00
600 Volts Delta	480Y/277 Volts	112.5	985	9T97C9635G03	\$76800.00
600 Volts Delta	480Y/277 Volts	150	1200	9T97C9636G03	\$88200.00
600 Volts Delta	480Y/277 Volts	225	1800	9T97C9637G03	\$152000.00
600 Volts Delta	480Y/277 Volts	300	2400	9T97C9638G03	\$176000.00
600 Volts Delta	480Y/277 Volts	500	3200	9T97C9639G03	\$280000.00



Publications and Reference: See Section 22 for a complete list of additional product-related publications

Transformers

Harmonic Mitigating – Guard III

Copper

Three-Phase TP-1

Section 8

0° & -30° Phase Shift NEMA 3R

Input Voltage	Output Voltage	kVA	Approx. Net Weight (Lbs.)	Product Number	List Price GO-67E
208 Volts Delta	208V/120 Volts	15	220	9T98C9091G03	\$35360.00
208 Volts Delta	208V/120 Volts	30	360	9T98C9092G03	\$39135.00
208 Volts Delta	208V/120 Volts	45	465	9T98C9093G03	\$50741.00
208 Volts Delta	208V/120 Volts	75	740	9T98C9094G03	\$70720.00
208 Volts Delta	208V/120 Volts	112.5	985	9T98C9095G03	\$99840.00
208 Volts Delta	208V/120 Volts	150	1200	9T98C9096G03	\$114660.00
208 Volts Delta	208V/120 Volts	225	1800	9T98C9097G03	\$197600.00
208 Volts Delta	208V/120 Volts	300	2400	9T98C9098G03	\$228800.00
208 Volts Delta	208V/120 Volts	500	3200	9T98C9099G03	\$364000.00
208 Volts Delta	480V/277 Volts	15	220	9T98C9801G03	\$35360.00
208 Volts Delta	480V/277 Volts	30	360	9T98C9802G03	\$39135.00
208 Volts Delta	480V/277 Volts	45	465	9T98C9803G03	\$50741.00
208 Volts Delta	480V/277 Volts	75	740	9T98C9804G03	\$70720.00
208 Volts Delta	480V/277 Volts	112.5	985	9T98C9805G03	\$99840.00
208 Volts Delta	480V/277 Volts	150	1200	9T98C9806G03	\$114660.00
208 Volts Delta	480V/277 Volts	225	1800	9T98C9807G03	\$197600.00
208 Volts Delta	480V/277 Volts	300	2400	9T98C9808G03	\$228800.00
208 Volts Delta	480V/277 Volts	500	3200	9T98C9809G03	\$312000.00
480 Volts Delta	208V/120 Volts	15	220	9T98C9871G03	\$29466.00
480 Volts Delta	208V/120 Volts	30	360	9T98C9872G03	\$32612.00
480 Volts Delta	208V/120 Volts	45	465	9T98C9873G03	\$42284.00
480 Volts Delta	208V/120 Volts	75	740	9T98C9874G03	\$58933.00
480 Volts Delta	208V/120 Volts	112.5	985	9T98C9875G03	\$83200.00
480 Volts Delta	208V/120 Volts	150	1200	9T98C9876G03	\$95550.00
480 Volts Delta	208V/120 Volts	225	1800	9T98C9877G03	\$164666.00
480 Volts Delta	208V/120 Volts	300	2400	9T98C9878G03	\$190666.00
480 Volts Delta	208V/120 Volts	500	3200	9T98C9879G03	\$303333.00
480 Volts Delta	480V/277 Volts	15	220	9T98C9851G03	\$35360.00
480 Volts Delta	480V/277 Volts	30	360	9T98C9852G03	\$39135.00
480 Volts Delta	480V/277 Volts	45	465	9T98C9853G03	\$50741.00
480 Volts Delta	480V/277 Volts	75	740	9T98C9854G03	\$70720.00
480 Volts Delta	480V/277 Volts	112.5	985	9T98C9855G03	\$99840.00
480 Volts Delta	480V/277 Volts	150	1200	9T98C9856G03	\$114660.00
480 Volts Delta	480V/277 Volts	225	1800	9T98C9857G03	\$197600.00
480 Volts Delta	480V/277 Volts	300	2400	9T98C9858G03	\$228800.00
480 Volts Delta	480V/277 Volts	500	3200	9T98C9859G03	\$312000.00
600 Volts Delta	208V/120 Volts	15	220	9T98C9891G03	\$29466.00
600 Volts Delta	208V/120 Volts	30	360	9T98C9892G03	\$32612.00
600 Volts Delta	208V/120 Volts	45	465	9T98C9893G03	\$42284.00
600 Volts Delta	208V/120 Volts	75	740	9T98C9894G03	\$58933.00
600 Volts Delta	208V/120 Volts	112.5	985	9T98C9895G03	\$83200.00
600 Volts Delta	208V/120 Volts	150	1200	9T98C9896G03	\$95550.00
600 Volts Delta	208V/120 Volts	225	1800	9T98C9897G03	\$164666.00
600 Volts Delta	208V/120 Volts	300	2400	9T98C9898G03	\$190666.00
600 Volts Delta	208V/120 Volts	500	3200	9T98C9899G03	\$260000.00
600 Volts Delta	480V/277 Volts	15	220	9T98C9631G03	\$35360.00
600 Volts Delta	480V/277 Volts	30	360	9T98C9632G03	\$39135.00
600 Volts Delta	480V/277 Volts	45	465	9T98C9633G03	\$50741.00
600 Volts Delta	480V/277 Volts	75	740	9T98C9634G03	\$70720.00
600 Volts Delta	480V/277 Volts	112.5	985	9T98C9635G03	\$99840.00
600 Volts Delta	480V/277 Volts	150	1200	9T98C9636G03	\$114660.00
600 Volts Delta	480V/277 Volts	225	1800	9T98C9637G03	\$197600.00
600 Volts Delta	480V/277 Volts	300	2400	9T98C9638G03	\$228800.00
600 Volts Delta	480V/277 Volts	500	3200	9T98C9639G03	\$312000.00



Transformers

Harmonic Mitigating – Guard III

Copper

Three-Phase TP-1

-15° & -45° Phase Shift NEMA 3R

Input Voltage	Output Voltage	kVA	Approx. Net Weight (Lbs.)	Product Number	List Price GO-67E
208 Volts Delta	208Y/120 Volts	15	220	9T99C9091G03	\$35360.00
208 Volts Delta	208Y/120 Volts	30	360	9T99C9092G03	\$39135.00
208 Volts Delta	208Y/120 Volts	45	465	9T99C9093G03	\$50741.00
208 Volts Delta	208Y/120 Volts	75	740	9T99C9094G03	\$70720.00
208 Volts Delta	208Y/120 Volts	112.5	985	9T99C9095G03	\$99840.00
208 Volts Delta	208Y/120 Volts	150	1200	9T99C9096G03	\$114660.00
208 Volts Delta	208Y/120 Volts	225	1800	9T99C9097G03	\$197600.00
208 Volts Delta	208Y/120 Volts	300	2400	9T99C9098G03	\$228800.00
208 Volts Delta	208Y/120 Volts	500	3200	9T99C9099G03	\$312000.00
208 Volts Delta	480Y/277 Volts	15	220	9T99C9801G03	\$35360.00
208 Volts Delta	480Y/277 Volts	30	360	9T99C9802G03	\$39135.00
208 Volts Delta	480Y/277 Volts	45	465	9T99C9803G03	\$50741.00
208 Volts Delta	480Y/277 Volts	75	740	9T99C9804G03	\$70720.00
208 Volts Delta	480Y/277 Volts	112.5	985	9T99C9805G03	\$99840.00
208 Volts Delta	480Y/277 Volts	150	1200	9T99C9806G03	\$114660.00
208 Volts Delta	480Y/277 Volts	225	1800	9T99C9807G03	\$197600.00
208 Volts Delta	480Y/277 Volts	300	2400	9T99C9808G03	\$228800.00
208 Volts Delta	480Y/277 Volts	500	3200	9T99C9809G03	\$312000.00
480 Volts Delta	208Y/120 Volts	15	220	9T99C9871G03	\$29466.00
480 Volts Delta	208Y/120 Volts	30	360	9T99C9872G03	\$32612.00
480 Volts Delta	208Y/120 Volts	45	465	9T99C9873G03	\$42284.00
480 Volts Delta	208Y/120 Volts	75	740	9T99C9874G03	\$58933.00
480 Volts Delta	208Y/120 Volts	112.5	985	9T99C9875G03	\$83200.00
480 Volts Delta	208Y/120 Volts	150	1200	9T99C9876G03	\$95550.00
480 Volts Delta	208Y/120 Volts	225	1800	9T99C9877G03	\$164666.00
480 Volts Delta	208Y/120 Volts	300	2400	9T99C9878G03	\$190666.00
480 Volts Delta	208Y/120 Volts	500	3200	9T99C9879G03	\$260000.00
480 Volts Delta	480Y/277 Volts	15	220	9T99C9851G03	\$35360.00
480 Volts Delta	480Y/277 Volts	30	360	9T99C9852G03	\$39135.00
480 Volts Delta	480Y/277 Volts	45	465	9T99C9853G03	\$50741.00
480 Volts Delta	480Y/277 Volts	75	740	9T99C9854G03	\$70720.00
480 Volts Delta	480Y/277 Volts	112.5	985	9T99C9855G03	\$99840.00
480 Volts Delta	480Y/277 Volts	150	1200	9T99C9856G03	\$114660.00
480 Volts Delta	480Y/277 Volts	225	1800	9T99C9857G03	\$197600.00
480 Volts Delta	480Y/277 Volts	300	2400	9T99C9858G03	\$228800.00
480 Volts Delta	480Y/277 Volts	500	3200	9T99C9859G03	\$312000.00
600 Volts Delta	208Y/120 Volts	15	220	9T99C9891G03	\$29466.00
600 Volts Delta	208Y/120 Volts	30	360	9T99C9892G03	\$32612.00
600 Volts Delta	208Y/120 Volts	45	465	9T99C9893G03	\$42284.00
600 Volts Delta	208Y/120 Volts	75	740	9T99C9894G03	\$58933.00
600 Volts Delta	208Y/120 Volts	112.5	985	9T99C9895G03	\$83200.00
600 Volts Delta	208Y/120 Volts	150	1200	9T99C9896G03	\$95550.00
600 Volts Delta	208Y/120 Volts	225	1800	9T99C9897G03	\$164666.00
600 Volts Delta	208Y/120 Volts	300	2400	9T99C9898G03	\$190666.00
600 Volts Delta	208Y/120 Volts	500	3200	9T99C9899G03	\$260000.00
600 Volts Delta	480Y/277 Volts	15	220	9T99C9631G03	\$35360.00
600 Volts Delta	480Y/277 Volts	30	360	9T99C9632G03	\$39135.00
600 Volts Delta	480Y/277 Volts	45	465	9T99C9633G03	\$50741.00
600 Volts Delta	480Y/277 Volts	75	740	9T99C9634G03	\$70720.00
600 Volts Delta	480Y/277 Volts	112.5	985	9T99C9635G03	\$99840.00
600 Volts Delta	480Y/277 Volts	150	1200	9T99C9636G03	\$114660.00
600 Volts Delta	480Y/277 Volts	225	1800	9T99C9637G03	\$197600.00
600 Volts Delta	480Y/277 Volts	300	2400	9T99C9638G03	\$228800.00
600 Volts Delta	480Y/277 Volts	500	3200	9T99C9639G03	\$312000.00



Publications and Reference: See Section 22 for a complete list of additional product-related publications

Transformers

Servicenter Mini-Unit Substations

Integral Transformer and Distribution Center

Product Description

This easily installed and serviceable unit incorporates a Type QMS transformer (single-phase) or a Type QL transformer (three-phase), a primary main circuit breaker, a secondary main circuit breaker, and a load-center-design breaker panel. Since these components don't have to be installed and interconnected separately, the contractor or user can reduce installation time and costs. Because of the single-unit concept, only one, handy Servicenter needs to be mounted.

Available in single-phase, 5 through 25 kVA, and in three-phase, 15 through 30 kVA, 600 Volt class ratings, the GE Servicenter is a convenient, economical way to meet your industrial and temporary power requirements.

The Transformer—The Servicenter utilizes GE transformer design which has twenty years of field-proven experience behind it and a long track record for assuring consistent, reliable performance. Type QMS transformers employ a 180°C UL Recognized insulation system with a 115°C rise. Type QL transformers employ a 220°C UL Recognized insulation system with a 150°C rise.

The Panel—The panel assembly includes the rugged GE PowerMark Plus™ circuit breaker load center interior, E-frame primary breakers, and E-frame or Q Line secondary breakers. The load center will accept one-, two-, or three-pole (three-phase) common trip circuit breakers and ground fault breakers. All Servicenters come equipped with the properly sized primary main and secondary main circuit breakers installed and prewired. Branch breakers are not included.

Advantages

- Transformer, distribution panel and breakers are all designed, built and assembled by GE
- Saves time and money - pre-assembled, pre-wired unit saves time on the job
- High reliability - assembled and tested in our UL approved factory to assure consistency and quality
- Available GE ground-fault breakers ensure electrical safety around construction sites or wherever water may be present

Key Features

- Keyhole mounting flange facilitates easy mounting
- Indoor and outdoor use
- Front-accessible, hinged or removable panel door is safe and convenient
- Heat barrier under core and coil provides electrical and thermal isolation for wiring compartment
- High-efficiency core construction results in quiet transformer operation and low no-load losses
- Factory installed and wired GE main and secondary main circuit breakers

Application

The single-phase Servicenter can be used wherever 480 Volt power is available and 120 or 240 Volt branch circuits are required. The three-phase Servicenter can be used wherever 240 Volt Δ , 480 Volt Δ or 600 Volt Δ is available and 208 Volt Y/120 Volt circuits are required. The unit can be used in such applications as vending machine areas, construction laboratory test areas, general construction sites where temporary or quickly obtained power is required, or where future expansion of branch circuits is planned.

- Vending or concession areas
- Office buildings
- Assembly lines
- Mining applications
- Parking lots
- Light industrial areas
- Warehouses
- Construction sites

NEC Requirements

The Servicenter conforms with Article 450-3 of the 1993 National Electric Code.



Single-Phase Servicenter, Hinged Door Removed

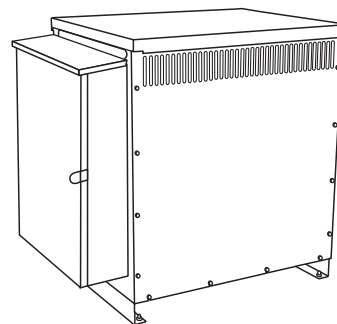

Three-Phase Servicenter, Closed View



Transformers

Servicenter Mini-Unit Substations

Integral Transformer and Distribution Center

Single-Phase and Three-Phase TP-1



Single-Phase Servicer

Single-Phase Indoor/Outdoor 60 Hz

Input Voltage	Output Voltage	kVA	Max. Branch Spaces 1 THQL, 1-pole	Max. Branch Spaces 1 THQL, 2-pole	Max. Branch Spaces 1/2 THQP, 1-pole	Max. Branch Spaces 1/2 THQP, 2-pole	Total 1-pole Spaces	Breaker Rating-Primary Main	Breaker Rating-Secondary Main	Product Number	List Price GO-66F
480 Volts	120/240 Volts	5	6	3	12	4	12	25A	30A	9T21S1050	\$1699.00
480 Volts	120/240 Volts	7.5	6	3	12	4	12	35A	40A	9T21S1070	\$1938.00
480 Volts	120/240 Volts	10	8	4	16	6	16	50A	50A	9T21S1100	\$2165.00
480 Volts	120/240 Volts	15	12	6	24	10	24	60A	70A	9T21S1150	\$2602.00
480 Volts	120/240 Volts	25	20	10	8	2	24	100A	150A	9T21S1250	\$3923.00

Three-Phase Indoor/Outdoor 60 Hz¹ TP-1

Input Voltage	Output Voltage	kVA	Max. Branch Spaces, 1-pole	Max. Branch Spaces 3-pole	Total 1-pole Spaces	Breaker Rating-Primary Main	Breaker Rating-Secondary Main	Product Number	List Price GO-67F
240 Volts	208Y/120 Volts	15	12	4	12	100A	50A	9T83B0001	\$9870.75
240 Volts	208Y/120 Volts	22.5	18	6	18	100A	70A	9T83B0002	\$13621.64
240 Volts	208Y/120 Volts	30	24	8	24	100A	100A	9T83B0003	\$12847.97
480 Volts	208Y/120 Volts	15	12	4	12	100A	50A	9T83B0011	\$9870.75
480 Volts	208Y/120 Volts	22.5	18	6	18	100A	70A	9T83B0012	\$12713.53
480 Volts	208Y/120 Volts	30	24	8	24	100A	100A	9T83B0013	\$12847.97
600 Volts	208Y/120 Volts	15	12	4	12	100A	50A	9T83B0021	\$9870.75
600 Volts	208Y/120 Volts	30	18	6	18	100A	70A	9T83B0022	\$12847.97
600 Volts	208Y/120 Volts	30	24	8	24	100A	100A	9T83B0023	\$12847.97

¹(3) 5% taps 1 above and 2 below rated primary volts.



Publications and Reference: See Section 22 for a complete list of additional product-related publications

Transformers

Servicenter Mini-Unit Substations

Integral Transformer and Distribution Center

Outlines, Dimensions and Wiring Diagrams

Single-Phase

kVA	Product Number	Approx. Net Weight (Lbs.)	"A" Height (in.)	"B" Width (in.)	"C" Depth (in.)	Frame Size
5	9T21S1050	103	32.5	10.75	11.12	16350
7.5	9T21S1070	147	32.5	10.75	11.12	16600
10	9T21S1100	198	35	12.62	12.62	19400
15	9T21S1150	220	35	12.62	12.62	19500
25	9T21S1250	388	44.75	16.75	16	50500

Three-Phase TP-1

kVA	Product Number	Approx. Net Weight (Lbs.)	"B" Height (in.)	"A" Width (in.)	Depth (in.)	Frame Size
15	9T83B0001	265	27.3	27.4	16.9	EE71
22.5	9T83B0002	375	32.2	34.5	24	EE72
30	9T83B0003	375	32.2	34.5	24	EE72
15	9T83B0011	265	27.3	27.4	16.9	EE71
22.5	9T83B0012	375	32.2	34.5	24	EE72
30	9T83B0013	375	32.2	34.5	24	EE72
15	9T83B0021	265	27.3	27.4	16.9	EE71
30	9T83B0022	375	32.2	34.5	24	EE72
30	9T83B0023	375	32.2	34.5	24	EE72

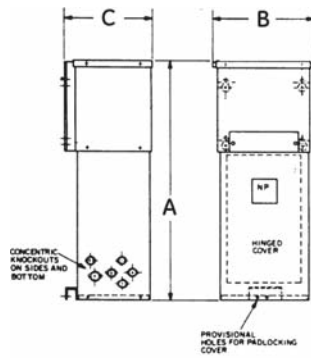

Dimensions Single-Phase

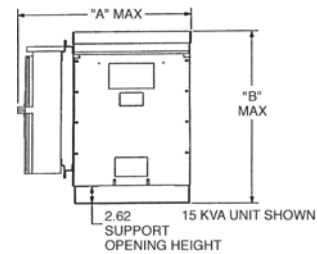

Dimensions Three-Phase

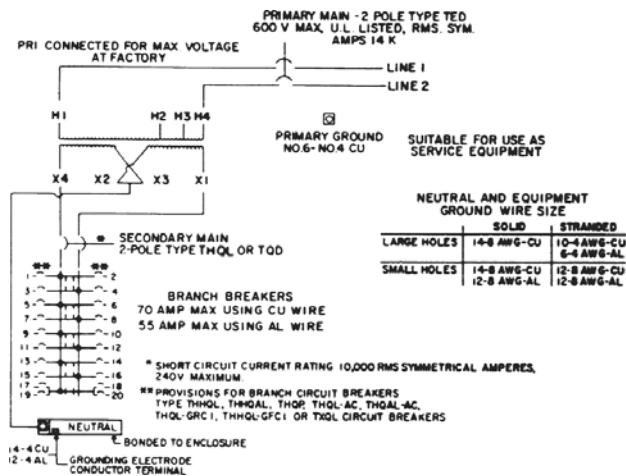

Typical Wiring Diagram Single-Phase

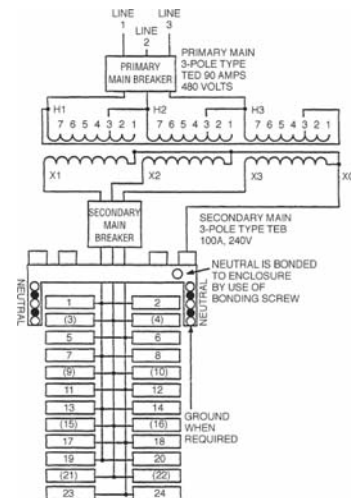

Typical Wiring Diagram Three-Phase¹

¹For 22.5 and 15 kVA three-phase Servicers, secondary main breaker is a backed plug-in type with positive retainers.



Transformers

Totally Enclosed, Nonventilated

TENV

15-75kVA, Three-Phase, TP-1

Totally enclosed nonventilated (TENV) transformers are an excellent choice for applications where dry-type transformer benefits are desired but the standard enclosure openings are unacceptable because of adverse atmospheric conditions. TENV transformers are recommended where dust, dirt or lint may be present or where transformers are subject to sprays or controlled wash-down conditions. They are UL Listed through 75kVA for indoor or protected outdoor applications.

Advantages

- Dry-type transformer is housed in an enclosed NEMA 3R non-ventilated compartment
- Convenient wiring compartment is located beneath the transformer and has removable front and rear covers
- Copper bus bars are located at the front of the wiring compartment and are clearly labeled
- All electrical connections between the transformer and bus bars are factory wired
- Quiet performance – meets NEMA ST-20
- No-weld coil termination design – an industry first
- Comprehensive factory testing assures quality

Features

- Quiet design - unique core and coil design makes GE TENV transformers among the quietest available
- Core and coil assembly mounted on rubber isolation pads to reduce noise
- Bolted coil terminations are more reliable than welded terminations, and they eliminate weld failures and problems associated with welding and weld splatter
- 100% factory tested for shorts and coil integrity, current and loss, voltage, impedance and noise
- Qualified to the seismic requirements of IEEE-693-1997 and IBC-2003
- Copper ground strap
- 220°C insulation system capable of 150°C rise, IS-19C
- Copper or aluminum windings available
- Available in 150°C, 115°C, and 80°C rise models
- Indoor or outdoor use
- NEMA TP-1 compliant

Applications

- Textile
- Automotive
- Foundry
- Paper mills
- Wash-down areas



TENV Transformer



TENV Transformer (front panel removed)



Publications and Reference: See Section 22 for a complete list of additional product-related publications

Transformers

Totally Enclosed, Nonventilated

TENV

Three-Phase TP-1

Section 8

Aluminum 150°C Rise

Input Voltage	Output Voltage	kVA	Taps	Net Weight (Lbs.)	Frame Size	Product Number	List Price GO-67A
480	208Y/120	15	(+2,-4 2.5%)	325	EE72	9T85B3871	\$8555.00
480	208Y/120	30	(+2,-4 2.3%)	390	EE73	9T85B3872	\$10278.00
480	208Y/120	45	(+2,-4 2.5%)	530	EE74	9T85B3873	\$12802.00
480	208Y/120	75	(+2,-4 2.6%)	650	EE75	9T85B3874	\$19863.00

Aluminum 115°C Rise

Input Voltage	Output Voltage	kVA	Taps	Net Weight (Lbs.)	Frame Size	Product Number	List Price GO-67A
480	208Y/120	15		375	EE72	9T85B3871G15	\$9651.00
480	208Y/120	30		430	EE73	9T85B3872G15	\$12562.00
480	208Y/120	45	(+2,-4 2.5%)	530	EE74	9T85B3873G15	\$15647.00

Aluminum 80°C Rise

Input Voltage	Output Voltage	kVA	Taps	Net Weight (Lbs.)	Frame Size	Product Number	List Price GO-67A
480	208Y/120	30		600	EE74	9T85B3872G80	\$13705.00
480	208Y/120	45		760	EE75	9T85B3873G80	\$17069.00

Copper 150°C Rise

Input Voltage	Output Voltage	kVA	Taps	Net Weight (Lbs.)	Frame Size	Product Number	List Price GO-67A
480	208Y/120	15	(+2,-4 2.5%)	325	EE72	9T85C9871	\$10529.00
480	208Y/120	30	(+2,-4 2.3%)	435	EE73	9T85C9872	\$13705.00
480	208Y/120	45	(+2,-4 2.4%)	530	EE74	9T85C9873	\$17069.00
480	208Y/120	75		820	EE75	9T85C9874	\$24447.00

Copper 115°C Rise

Input Voltage	Output Voltage	kVA	Taps	Net Weight (Lbs.)	Frame Size	Product Number	List Price GO-67A
480	208Y/120	15	(+2,-4 2.5%)	325	EE72	9T85C9871G15	\$11626.00
480	208Y/120	30		435	EE73	9T85C9872G15	\$15132.00
480	208Y/120	45	(+2,-4 2.4%)	530	EE74	9T85C9873G15	\$18847.00
480	208Y/120	75	(+2,-4 2.6%)	650	EE75	9T85C9874G15	\$26994.00

Copper 80°C Rise

Input Voltage	Output Voltage	kVA	Taps	Net Weight (Lbs.)	Frame Size	Product Number	List Price GO-67A
480	208Y/120	15		435	EE73	9T85C9871G80	\$12503.00
480	208Y/120	30		730	EE74	9T85C9872G80	\$16274.00
480	208Y/120	45		820	EE75	9T85C9873G80	\$20270.00



Transformers

Midtapped Three-Phase TP-1

Product Description

GE Type QL midtapped transformer enables the user to transform three-phase power from 480 Volts primary to 240 Volts secondary and have 120 Volt, reduced capacity tap (RCT) single-phase capability as well. This is because a single-phase midtap is brought out of one coil of the unit's three-phase secondary winding. These transformers are UL listed, File E-79145.

Application

The Type QL midtapped design can be used wherever there is 480 Volt, three-phase supply available and the load is primarily 240 Volt three-phase with a nominal amount of 120 Volt, single-phase power required. Normally, in this instance, a small single-phase as well as a three-phase transformer would be required to provide the necessary transformation.

Caution: When utilizing the 120 Volt midtap for single-phase applications, the single-phase load should not exceed 5 percent of the three-phase kVA rating. The three-phase kVA load must be reduced by the same percentage as that added by the single-phase load. Additional loading beyond 5 percent may cause the transformer to overheat and fail. If the single-phase load is in excess of 5 percent, it is recommended that a separate single-phase unit be used to handle the load.



Type QL Midtapped Transformer

Aluminum

150°C Rise 60Hz

Primary Voltage	Secondary Voltage	kVA	Taps	Net Weight (Lbs.)	Frame Size	Product Number	List Price	GO Schedule
480	240/120	15	(+2,-4 2.5%)	265	EE71	9T83B3841	\$6612.00	66K
480	240/120	30	(+2,-4 2.5%)	375	EE72	9T83B3842	\$7949.00	66K
480	240/120	45	(+2,-4 2.3%)	430	EE73	9T83B3843	\$6973.00	66K
480	240/120	75	(+2,-4 2.5%)	600	EE74	9T83B3844	\$8920.00	66K
480	240/120	112.5	(+2,-4 2.6%)	760	EE75	9T83B3845	\$11913.00	66K
480	240/120	150	(+2,-4 2.4%)	904	EE76	9T83B3846	\$13234.00	66K
480	240/120	225	(+2,-4 2.6%)	1585	EE77	9T83B3847	\$27302.00	67A
480	240/120	150	(+2,-4 2.4%)	845	FC77	9T40G0106	\$20315.00	66KG
480	240/120	225	(+2,-4 2.4%)	845	FC77	9T40G0107	\$16745.00	66KG
480	240/120	300	(+2,-4 2.7%)	1020	FC78	9T40G0108	\$27095.00	66KG
480	240/120	500	(+2,-4 1.8%)	1585	FC79	9T40G0109	\$59626.00	67AG

115°C Rise 60Hz

Primary Voltage	Secondary Voltage	kVA	Taps	Net Weight (Lbs.)	Frame Size	Product Number	List Price	GO Schedule
480	240/120	15		265	EE71	9T83B3841G15	\$6142.00	67A
480	240/120	30	(+2,-4 2.5%)	375	EE72	9T83B3842G15	\$7138.00	67A
480	240/120	45	(+2,-4 2.3%)	430	EE73	9T83B3843G15	\$8890.00	67A
480	240/120	75	(+2,-4 2.5%)	600	EE74	9T83B3844G15	\$12733.00	67A
480	240/120	112.5	(+2,-4 2.6%)	760	EE75	9T83B3845G15	\$17088.00	67A
480	240/120	150	(+2,-4 2.4%)	904	EE77	9T83B3846G15	\$24731.00	67A
480	240/120	150	(+2,-4 2.4%)	845	FC77	9T40G0106G51	\$22082.00	67AG
480	240/120	225	(+2,-4 2.7%)	1020	FC78	9T40G0107G51	\$29676.00	67AG

80°C Rise 60Hz

Primary Voltage	Secondary Voltage	kVA	Taps	Net Weight (Lbs.)	Frame Size	Product Number	List Price	GO Schedule
480	240/120	15	(+2,-4 2.5%)	265	EE71	9T83B3841G80	\$6361.00	67A
480	240/120	30	(+2,-4 2.3%)	430	EE73	9T83B3842G80	\$8280.00	67A
480	240/120	45	(+2,-4 2.5%)	600	EE74	9T83B3843G80	\$10313.00	67A
480	240/120	75	(+2,-4 2.5%)	600	EE74	9T83B3844G80	\$14770.00	67A
480	240/120	112.5	(+2,-4 2.4%)	845	FC77	9T40G0105G81	\$19822.00	67AG
480	240/120	150	(+2,-4 2.4%)	845	FC77	9T40G0106G81	\$25615.00	67AG



Publications and Reference: See Section 22 for a complete list of additional product-related publications

Transformers

Midtapped

Copper

Three-Phase TP-1

Section 8

150°C Rise 60Hz

Primary Voltage	Secondary Voltage	kVA	Taps	Net Weight (Lbs.)	Frame Size	Product Number	List Price	GO Schedule
480	240/120	15	(+2,-4 2.5%)	290	EE71	9T83C9841	\$7019.00	67AC
480	240/120	30	(+2,-4 2.5%)	435	EE72	9T83C9842	\$9136.00	67AC
480	240/120	45	(+2,-4 2.5%)	510	EE73	9T83C9843	\$11379.00	67AC
480	240/120	75	(+2,-4 2.5%)	730	EE74	9T83C9844	\$16298.00	67AC
480	240/120	112.5	(+2,-4 2.6%)	820	EE75	9T83C9845	\$21873.00	67AC
480	240/120	150	(+2,-4 2.4%)	965	EE76	9T83C9846	\$28264.00	67AC
480	240/120	225	(+2,-4 2.6%)	1700	EE77	9T83C9847	\$37986.00	67AC
480	240/120	225	(+2,-4 2.4%)	976	FC77	9T45G0107	\$37986.00	67AGC
480	240/120	300	(+2,-4 2.7%)	1160	FC78	9T45G0108	\$52704.00	67AGC
480	240/120	300	(+2,-4 2.7%)	1160	FC78	9T45G0108	\$52704.00	67AGC
480	240/120	500	(+2,-4 1.8%)	1700	FC79	9T45G0109	\$82958.00	67AGC

115°C Rise 60Hz

Primary Voltage	Secondary Voltage	kVA	Taps	Net Weight (Lbs.)	Frame Size	Product Number	List Price	GO Schedule
480	240/120	15	(+2,-4 2.5%)	290	EE71	9T83C9841G15	\$8116.00	67AC
480	240/120	45	(+2,-4 2.5%)	510	EE73	9T83C9843G15	\$13158.00	67AC
480	240/120	75	(+2,-4 2.5%)	730	EE74	9T83C9844G15	\$18845.00	67AC

80°C Rise 60Hz

Primary Voltage	Secondary Voltage	kVA	Taps	Net Weight (Lbs.)	Frame Size	Product Number	List Price	GO Schedule
480	240/120	75	(+2,-4 2.6%)	820	EE75	9T83C9844G80	\$20882.00	67AC
480	240/120	112.5	(+2,-4 2.4%)	820	EE75	9T83C9845G80	\$28024.00	67AC



Application

The use of SCR control circuitry with adjustable-speed drives has resulted in a need for a line of isolation transformers specifically designed to meet the demanding requirements of SCR drives. Symmetrically placed taps and added coil bracing minimize mechanical forces caused by the often severe SCR drive duty cycles. These features also help protect the transformer from the regenerative duty and more frequent short-circuits associated

with SCR drives. Isolation transformers also reduce line-pollution feedback resulting from SCR firing circuits. The GE delta-wye designs meet the NEC requirements for grounded secondary neutrals that isolate primary distribution systems. kVA ratings of the DIT line cover most dc motor requirements from 3 to 1000 hp. Enclosed drive isolation transformers are UL listed. Insulation systems (vacuum impregnated) are UL Recognized.

15 - 220 kVA Indoor Type QL UL Listed C-UL Listed

Input Voltage	Output Voltage	kVA	Frequency (Hz)	Wiring Diagram No. ¹	Weight (Lbs)	Frame Size	Product Number	List Price GO-185
230 Volts Delta	230 Y Volts	15	60 Hz	16	265	EE71	9T83B4000G29	\$6361.00
230 Volts Delta	230 Y Volts	20	60 Hz	16	375	EE72	9T83B4001G29	\$6310.85
230 Volts Delta	230 Y Volts	27	60 Hz	16	375	EE72	9T83B4002G29	\$7142.89
230 Volts Delta	230 Y Volts	34	60 Hz	16	430	EE73	9T83B4003G29	\$8214.33
230 Volts Delta	230 Y Volts	40	60 Hz	16	430	EE73	9T83B4004G29	\$9267.32
230 Volts Delta	230 Y Volts	51	60 Hz	16	600	EE74	9T83B4005G29	\$10750.09
230 Volts Delta	230 Y Volts	63	60 Hz	16	600	EE74	9T83B4006G29	\$10750.09
230 Volts Delta	230 Y Volts	75	60 Hz	16	600	EE74	9T83B4007G29	\$14770.28
230 Volts Delta	230 Y Volts	93	60 Hz	16	760	EE75	9T83B4008G29	\$14820.21
230 Volts Delta	230 Y Volts	118	60 Hz	16	904	EE76	9T83B4009G29	\$17812.76
230 Volts Delta	230 Y Volts	145	60 Hz	16	904	EE76	9T83B4010G29	\$19110.00
230 Volts Delta	230 Y Volts	175	60 Hz	16	1585	EE77	9T83B4011G29	\$25780.29
230 Volts Delta	460 Y Volts	15	60 Hz	16	265	EE71	9T83B4000G28	\$6361.15
230 Volts Delta	460 Y Volts	20	60 Hz	16	375	EE72	9T83B4001G28	\$6310.85
230 Volts Delta	460 Y Volts	27	60 Hz	16	375	EE72	9T83B4002G28	\$7142.89
230 Volts Delta	460 Y Volts	34	60 Hz	16	430	EE73	9T83B4003G28	\$8214.33
230 Volts Delta	460 Y Volts	40	60 Hz	16	430	EE73	9T83B4004G28	\$9267.32
230 Volts Delta	460 Y Volts	51	60 Hz	16	600	EE74	9T83B4005G28	\$10750.09
230 Volts Delta	460 Y Volts	63	60 Hz	16	600	EE74	9T83B4006G28	\$10750.09
230 Volts Delta	460 Y Volts	75	60 Hz	16	600	EE74	9T83B4007G28	\$14770.28
230 Volts Delta	460 Y Volts	93	60 Hz	16	760	EE75	9T83B4008G28	\$14820.21
230 Volts Delta	460 Y Volts	118	60 Hz	16	904	EE76	9T83B4009G28	\$17812.76
230 Volts Delta	460 Y Volts	145	60 Hz	16	904	EE76	9T83B4010G28	\$20255.94
230 Volts Delta	460 Y Volts	175	60 Hz	16	1585	EE77	9T83B4011G28	\$25780.29
230 Volts Delta	460 Y Volts	220	60 Hz	16	1585	EE77	9T83B4012G28	\$30934.96

¹See page 8-44 for wiring diagrams.



Transformers Drive Isolation Three-Phase

Section 8

15 - 220 kVA Indoor Type QL UL Listed C-UL Listed (continued)

Input Voltage	Output Voltage	kVA	Frequency (Hz)	Wiring Diagram No. ¹	Weight (Lbs)	Frame Size	Product Number	List Price GO-185
460 Volts Delta	230 Y Volts	15	60 Hz	16	265	EE71	9T83B4000G23	\$6361.00
460 Volts Delta	230 Y Volts	20	60 Hz	16	375	EE72	9T83B4001G23	\$5658.00
460 Volts Delta	230 Y Volts	27	60 Hz	16	375	EE72	9T83B4002G23	\$6404.00
460 Volts Delta	230 Y Volts	34	60 Hz	16	430	EE73	9T83B4003G23	\$8214.00
460 Volts Delta	230 Y Volts	40	60 Hz	16	430	EE73	9T83B4004G23	\$9267.00
460 Volts Delta	230 Y Volts	51	60 Hz	16	600	EE74	9T83B4005G23	\$9638.00
460 Volts Delta	230 Y Volts	63	60 Hz	16	600	EE74	9T83B4006G23	\$9638.00
460 Volts Delta	230 Y Volts	75	60 Hz	16	600	EE74	9T83B4007G23	\$13242.00
460 Volts Delta	230 Y Volts	93	60 Hz	16	760	EE75	9T83B4008G23	\$13287.00
460 Volts Delta	230 Y Volts	118	60 Hz	16	904	EE76	9T83B4009G23	\$15970.00
460 Volts Delta	230 Y Volts	145	60 Hz	16	904	EE76	9T83B4010G23	\$20255.94
460 Volts Delta	230 Y Volts	175	60 Hz	16	1585	EE77	9T83B4011G23	\$25780.29
460 Volts Delta	230 Y Volts	220	60 Hz	16	1585	EE77	9T83B4012G23	\$30934.96
460 Volts Delta	460 Y Volts	15	60 Hz	16	265	EE71	9T83B4000G22	\$5981.00
460 Volts Delta	460 Y Volts	20	60 Hz	16	375	EE72	9T83B4001G22	\$5936.00
460 Volts Delta	460 Y Volts	27	60 Hz	16	375	EE72	9T83B4002G22	\$6685.00
460 Volts Delta	460 Y Volts	34	60 Hz	16	430	EE73	9T83B4003G22	\$7649.00
460 Volts Delta	460 Y Volts	40	60 Hz	16	430	EE73	9T83B4004G22	\$8597.00
460 Volts Delta	460 Y Volts	51	60 Hz	16	600	EE74	9T83B4005G22	\$9931.00
460 Volts Delta	460 Y Volts	63	60 Hz	16	600	EE74	9T83B4006G22	\$9931.00
460 Volts Delta	460 Y Volts	75	60 Hz	16	600	EE74	9T83B4007G22	\$13242.32
460 Volts Delta	460 Y Volts	93	60 Hz	16	760	EE75	9T83B4008G22	\$13594.00
460 Volts Delta	460 Y Volts	112.5	60 Hz	16	760	EE75	9T83B4158G22	\$23240.00
460 Volts Delta	460 Y Volts	118	60 Hz	16	904	EE76	9T83B4009G22	\$16287.00
460 Volts Delta	460 Y Volts	145	60 Hz	16	904	EE76	9T83B4010G22	\$18486.00
460 Volts Delta	460 Y Volts	161	60 Hz	16	1585	EE77	9T83B4641G22	\$23018.12
460 Volts Delta	460 Y Volts	175	60 Hz	16	1585	EE77	9T83B4011G22	\$26125.00
460 Volts Delta	460 Y Volts	220	60 Hz	16	1585	EE77	9T83B4012G22	\$31298.00
575 Volts Delta	230 Y Volts	15	60 Hz	16	265	EE71	9T83B4000G27	\$6361.15
575 Volts Delta	230 Y Volts	20	60 Hz	16	375	EE72	9T83B4001G27	\$6310.85
575 Volts Delta	230 Y Volts	27	60 Hz	16	375	EE72	9T83B4002G27	\$7142.89
575 Volts Delta	230 Y Volts	34	60 Hz	16	430	EE73	9T83B4003G27	\$8214.33
575 Volts Delta	230 Y Volts	40	60 Hz	16	430	EE73	9T83B4004G27	\$9267.32
575 Volts Delta	230 Y Volts	51	60 Hz	16	600	EE74	9T83B4005G27	\$10750.09
575 Volts Delta	230 Y Volts	63	60 Hz	16	600	EE74	9T83B4006G27	\$10750.09
575 Volts Delta	230 Y Volts	75	60 Hz	16	600	EE74	9T83B4007G27	\$14770.28
575 Volts Delta	230 Y Volts	93	60 Hz	16	760	EE75	9T83B4008G27	\$14820.21
575 Volts Delta	230 Y Volts	118	60 Hz	16	904	EE76	9T83B4009G27	\$17812.76
575 Volts Delta	230 Y Volts	145	60 Hz	16	904	EE76	9T83B4010G27	\$20255.94
575 Volts Delta	230 Y Volts	175	60 Hz	16	1585	EE77	9T83B4011G27	\$25780.29
575 Volts Delta	230 Y Volts	220	60 Hz	16	1585	EE77	9T83B4012G27	\$30934.96
575 Volts Delta	460 Y Volts	15	60 Hz	16	265	EE71	9T83B4000G26	\$6361.15
575 Volts Delta	460 Y Volts	20	60 Hz	16	375	EE72	9T83B4001G26	\$6311.00
575 Volts Delta	460 Y Volts	27	60 Hz	16	375	EE72	9T83B4002G26	\$7143.00
575 Volts Delta	460 Y Volts	34	60 Hz	16	430	EE73	9T83B4003G26	\$8214.00
575 Volts Delta	460 Y Volts	40	60 Hz	16	430	EE73	9T83B4004G26	\$9267.32
575 Volts Delta	460 Y Volts	51	60 Hz	16	600	EE74	9T83B4005G26	\$10750.00
575 Volts Delta	460 Y Volts	63	60 Hz	16	600	EE74	9T83B4006G26	\$10750.00
575 Volts Delta	460 Y Volts	75	60 Hz	16	600	EE74	9T83B4007G26	\$14770.00
575 Volts Delta	460 Y Volts	93	60 Hz	16	760	EE75	9T83B4008G26	\$14820.00
575 Volts Delta	460 Y Volts	118	60 Hz	16	904	EE76	9T83B4009G26	\$17812.76
575 Volts Delta	460 Y Volts	145	60 Hz	16	904	EE76	9T83B4010G26	\$20255.94
575 Volts Delta	460 Y Volts	175	60 Hz	16	1585	EE77	9T83B4011G26	\$25780.29
575 Volts Delta	460 Y Volts	220	60 Hz	16	1585	EE77	9T83B4012G26	\$30934.96

¹See page 8-44 for wiring diagrams.

NOTE: Full capacity symmetrical taps (1) +5% and (1) -5%, in primary windings for 230 and 460 Y thru 550 kVA; (1) +6.2% and (1) -6.2% at 750 kVA; (1) +6.4% and (1) -6.4% at 1000 kVA. With 575 V primary, symmetrical 5% taps apply thru 750 kVA; at 1000 kVA, (1) +5.1% and (1) -5.1%. For ratings less than 15 kV contact GE Consumer & Industrial Sales Office.

Conversion Chart

Decimal	Fraction
.13	1/8
.38	3/8
.63	5/8
.88	7/8



Transformers Drive Isolation Three-Phase

Drive Isolation TransforMore® NEMA 2

Primary Voltage	Secondary Voltage	kVA	Taps	Wiring Diagram No. ¹	Weight (Lbs)	Frame Size	Product Number	List Price GO-185
575 Volts Delta	460Y/266	225 kVA	(+1, -1 4.8%)	16	845	FC77	9T40G6007	\$34424.42
575 Volts Delta	460Y/266	440 kVA	(+1, -1 5.3%)	16	1585	FC79	9T40G6090	\$73412.79
480 Volts Delta	480Y/277	630 kVA	(+1, -1 4.7%)	16	3250	FC67	9T40G6291	\$94727.55
480 Volts Delta	400Y/231	750 kVA	(+1, -1 5.7%)	16	3250	FC67	9T40G6310	\$112770.90
480 Volts Delta	400Y/231	550 kVA	(+1, -1 5.7%)	16	3250	FC67	9T40G6392	\$82698.66
460 Volts Delta	460Y/266	225 kVA	(+1, -1 5.0%)	16	845	FC77	9T40G6407	\$34424.42
460 Volts Delta	460Y/266	175 kVA	(+1, -1 5.0%)	16	845	FC77	9T40G6467	\$25780.29
460 Volts Delta	460Y/266	275 kVA	(+1, -1 4.9%)	16	1020	FC78	9T40G6478	\$41093.87
460 Volts Delta	460Y/266	550 kVA	(+1, -1 5.0%)	16	3250	FC67	9T40G6492	\$82698.66
460 Volts Delta	460Y/266	660 kVA	(+1, -1 5.0%)	16	3250	FC67	9T40G6493	\$99238.39
480 Volts Delta	380Y/219	220 kVA	(+1, -1 4.5%)	16	3250	FC78	9T40G6807G81	\$30934.96
480 Volts Delta	380Y/219	275 kVA	(+1, -1 4.5%)	16	3250	FC78	9T40G6878	\$41093.87
415 Volts Delta	460Y/266	440 kVA	(+1, -1 4.9%)	16	1585	FC79	9T40G9090G41	\$83538.69
380 Volts Delta	460Y/266	275 kVA	(+1, -1 5.3%)	16	1585	FC79	9T40G9178G51	\$53847.14
400 Volts Delta	460Y/266	150 kVA	(+1, -1 5.4%)	16	845	FC77	9T40G9306	\$29147.60
415 Volts Delta	220/110	500 kVA	(+1, -1 4.9%)	16	1585	FC79	9T40G9409	\$85550.33
460 Volts Delta	460Y/266	150 kVA	(+1, -1 5.0%)	16	976	FC77	9T45G6406G53	\$40629.99
460 Volts Delta	460Y/266	225 kVA	(+1, -1 4.9%)	16	1160	FC78	9T45G6407G53	\$54604.25
460 Volts Delta	460Y/266	550 kVA	(+1, -1 4.9%)	16	1160	FC78	9T45G6492	\$108363.76
460 Volts Delta	460Y/266	275 kVA	(+1, -1 4.9%)	16	3250	FC78	9T40G6478	\$41093.87
460 Volts Delta	460Y/266	440 kVA	(+1, -1 4.7%)	16	1585	FC79	9T40G6490	\$66160.00
400 Volts Delta	460Y/266	150 kVA	(+1, -1 5.4%)	16	845	FC77	9T40G9306	\$29147.60
400 Volts Delta	460Y/266	150 kVA	(+1, -1 5.4%)	16	845	FC77	9T40G9306G41	\$29147.60

¹See page 8-44 for wiring diagrams.



Publications and Reference: See Section 22 for a complete list of additional product-related publications

Transformers Accessories and Lugs Single-Phase and Three-Phase

Wall Mount Bracket

Frame Size	Product Number	List Price GO-66C
E171	9T18Y5042	\$141.00
E172	9T18Y5043	\$196.00
E173	9T18Y5043	\$196.00
EE75 and larger	Not Available	
EE71	9T18Y5042	\$141.00
EE72	9T18Y5042	\$141.00
EE73	9T18Y5042	\$141.00
EE74	9T18Y5043	\$196.00
EE174	Not Available	

Rainshield Kit

Frame Size	Product Number	List Price GO-66C
E171	9T18Y4317G05	\$256.00
E172	9T18Y4317G06	\$256.00
E173	9T18Y4317G06	\$256.00
E174	9T18Y4317G06	\$256.00
EE71	9T18Y4317G11	\$256.00
EE72	9T18Y4317G05	\$256.00
EE73	9T18Y4317G05	\$256.00
EE74	9T18Y4317G06	\$256.00
EE75	9T18Y4317G06	\$256.00
EE76	9T18Y4317G07	\$359.00
EE77	9T18Y4322G79	\$359.00
FC67	9T18Y4322G68	\$359.00
FC68	9T18Y4322G68	\$359.00
FC77	9T18Y4322G77	\$359.00
FC78	9T18Y4322G78	\$359.00
FC79	9T18Y4322G79	\$359.00

Bottom Pan (TransforMore® only)

Frame Size	Product Number	List Price GO-66C
FC77	9T18Y4504G77	\$164.00
FC78	9T18Y4504G78	\$176.00
FC79	9T18Y4504G79	\$233.00
FC68	9T18Y4504G68	\$271.00
FC67	9T18Y4504G68	\$271.00

Lug Kits for QL Transformers

Frame Size	Product Number	List Price GO-66C
E171	9T18Y7240G02	\$130.00
E172	9T18Y7240G02	\$130.00
E173	9T18Y7241G03	\$170.00
E174	9T18Y7240G03	\$250.00
EE71	9T18Y7327	\$70.00
EE72	9T18Y7240	\$150.00
EE73	9T18Y7240	\$150.00
EE74	9T18Y7241	\$225.00
EE75	9T18Y7242	\$225.00
EE76	9T18Y7242G03	\$350.00
EE77	9T18Y7242G06	\$1050.00

Lug Kit Information for QL Transformers

Frame Size	Typical Transformer Size	Primary Bus Bar Holes (Qty/Size)	Secondary Bus Bar Holes (Qty/Size)	Kit Number	Specified Lug Kit					
					Lug Size No.1			Lug Size No.2		
					Qty	Conductor Size	Stud Hole Size	Qty	Conductor Size	Stud Hole Size
E171	1 ph - 25 kVA (2671)	(2) .406 dia	(2) .406 dia	9T18Y7240G02 ¹	8	6 AWG to 250 MCM	5/16	N/A	N/A	N/A
E172	1 ph - 37.5 kVA (2672)	(2) .406 dia	(2) .406 dia	9T18Y7241G03	4	6 AWG to 250 MCM	5/16	4	6 AWG to 350 MCM	3/8
E173	1 ph - 50 kVA (2673)	(2) .406 dia	(2) .406 dia	9T18Y7240G03	12	6 AWG to 250 MCM	5/16	N/A	N/A	N/A
E174	1 ph - 75 kVA (2674)	(2) .406 dia	(2) .406 dia	9T18Y7241	3	6 AWG to 250 MCM	5/16	8	6 AWG to 350 MCM	3/8
EE71	3 ph - 15 kVA (3871)	(1) .406 dia	(1) .406 dia	9T18Y7327 ¹	7	14 AWG to 1/0 AWG	1/4	N/A	N/A	N/A
EE72/EE73	3 ph - 30/45 kVA (3872/3873)	(1) .406 dia	(1) .406 dia	9T18Y7240 ¹	7	6 AWG to 250 MCM	5/16	N/A	N/A	N/A
EE74	3 ph - 75 kVA (3874)	(2) .406 dia	(2) .406 dia	9T18Y7241	3	6 AWG to 250 MCM	5/16	8	6 AWG to 350 MCM	3/8
EE75	3 ph - 112.5 kVA (3875)	(2) .406 dia	(2) .406 dia	9T18Y7242	11	6 AWG to 350 MCM	3/8	N/A	N/A	N/A
EE76	3 ph - 150 kVA (3876)	(2) .406 dia	(2) .406 dia	9T18Y7242G03	3	6 AWG to 350 MCM	3/8	8	4 AWG to 500 MCM	3/8
EE77	3 ph - 225 kVA (3877)	(2) .406 dia	(4) .406 dia	9T18Y7242G02	22	6 AWG to 350 MCM	3/8	N/A	N/A	N/A

¹Proximity of bus bars would prohibit dual lugs per bus bar

TransforMore® Disconnect Switch Lug Information

(TransforMore® transformers are supplied with lugs on the primary side of the disconnect switch. This chart provides information on those lugs.)

Frame Size	Lug Part No.	Amps	Qty of Holes Per Lug	Qty of Lugs Per Phase	Primary Load Lugs					
					Lug Hole No.1		Lug Hole No.2		Lug Hole No.3	
					Dia (in.)	UL Certified Wire Sizes Cu-AL	Dia (in.)	UL Certified Wire Sizes Cu-AL	Dia (in.)	UL Certified Wire Sizes Cu-AL
FC77	TCAL43 ²	thru 400	2	1	0.922	2/0 - 600 Kcmil Cu or Al	0.609	6 - 250 Kcmil Cu or Al	N/A	N/A
FC78	TCAL63 ³	450-600	2	1	0.844	4/0-350 Kcmil Cu or 3/0-500 Kcmil Al	0.844	4/0-350 Kcmil Cu or 3/0-500 Kcmil Al	N/A	N/A
FC79	TCAL81 ⁴	700-1000	3	1	0.844	3/0-500 Kcmil Cu or Al	0.844	3/0-500 Kcmil Cu or Al	0.844	500 MCM
FC67	TCAL81 ⁴	700-1000	3	2	0.844	3/0-500 Kcmil Cu or Al	0.844	3/0-500 Kcmil Cu or Al	0.844	500 MCM
FC68	TCAL81 ⁴	700-1000	3	2	0.844	3/0-500 Kcmil Cu or Al	0.844	3/0-500 Kcmil Cu or Al	0.844	500 MCM

²May use twin 250 Kcmil Cu or Al.

³The TCAL43 lugs could be substituted for the TCAL63 lugs to give customer a 600 mcm hole.

⁴The TCAL124 lugs can be substituted for the TCAL81 lugs. TCAL124 = 3 holes at 350-750 Kcmil (1.055 dia) > some sizing differences.



Enclosure Parts for TransforMore® Transformers

Description	Frame Size									
	FC77 (225 kVA frame size)		FC78 (300 kVA frame size)		FC79 (500 kVA frame size)		FC67 (750 kVA frame size)		FC68 (1000 kVA frame size)	
	Product No.	List Price	Product No.	List Price	Product No.	List Price	Product No.	List Price	Product No.	List Price
Cover (Top) Panel	9T18Y4501G77	\$182.00	9T18Y4501G78	\$191.00	9T18Y4501G79	\$244.00	9T18Y4501G68	\$324.00	9T18Y4501G68	\$324.00
Front/Back Panel	9T18Y4502G77	\$274.00	9T18Y4502G78	\$319.00	9T18Y4502G79	\$418.00	9T18Y4502G68	\$495.00	9T18Y4502G68	\$495.00
Grill, Front/Back	9T18Y4503G77	\$96.00	9T18Y4503G78	\$120.00	9T18Y4503G79	\$132.00	9T18Y4503G68	\$234.00	9T18Y4503G68	\$234.00
Bottom Pan	9T18Y4504G77	\$164.00	9T18Y4504G78	\$176.00	9T18Y4504G79	\$233.00	9T18Y4504G68	\$271.00	9T18Y4504G68	\$271.00
Side Panel	9T18Y4505G77	\$380.00	9T18Y4505G78	\$424.00	9T18Y4505G79	\$512.00	9T18Y4505G68	\$585.00	9T18Y4505G68	\$585.00
Enclosure Kit ¹	9T18Y4506G77	\$1846.00	9T18Y4506G78	\$2093.00	9T18Y4506G79	\$2601.00	9T18Y4506G68	\$3105.00	9T18Y4506G68	\$3105.00
Fan Assembly	9T18Y4507G77	\$639.00	9T18Y4507G78	\$648.00	9T18Y4507G79	\$650.00	9T18Y4507G68	\$775.00	9T18Y4507G68	\$775.00
Isomode Pads	9T18Y4508G77	\$31.00	9T18Y4508G78	\$31.00	9T18Y4508G79	\$112.00	9T18Y4508G68	\$112.00	9T18Y4508G68	\$112.00
Disconnect Switch	9T18Y4509G77	\$6920.00	9T18Y4509G78	\$6920.00	9T18Y4509G79	\$6920.00	9T18Y4509G68	\$6920.00	9T18Y4509G68	\$6920.00
Rainshield Kit	9T18Y4322G77	\$359.00	9T18Y4322G78	\$359.00	9T18Y4322G79	\$359.00	9T18Y4322G68	\$359.00	9T18Y4322G68	\$359.00

¹Enclosure Kit Contains 2 Side Panels, 2 Front/Back panels, and Cover

Enclosure Parts for QL Transformers

Frame Size	Enclosure Kit ²		Front/Back Panel		Side Panel		Cover (Top) Panel		Base	
	Product No.	List Price	Product No.	List Price	Product No.	List Price	Product No.	List Price	Product No.	List Price
EE71	9T18Y4421	\$297.00	9T18Y4421G03	\$106.00	9T18Y4421G04	\$104.00	9T18Y4421G05	\$118.00		
EE72	9T18Y4412	\$307.00	9T18Y4412G03	\$108.00	9T18Y4412G04	\$105.00	9T18Y4412G05	\$105.00		
EE73	9T18Y4412	\$307.00	9T18Y4412G03	\$108.00	9T18Y4412G04	\$105.00	9T18Y4412G05	\$105.00		
EE74	9T18Y4413	\$358.00	9T18Y4413G03	\$119.00	9T18Y4413G04	\$112.00	9T18Y4414G05	\$133.00		
EE75	9T18Y4414	\$370.00	9T18Y4414G03	\$124.00	9T18Y4414G04	\$124.00	9T18Y4414G05	\$133.00		
EE76	9T18Y4415	\$540.00	9T18Y4415G03	\$202.00	9T18Y4415G04	\$212.00	9T18Y4415G05	\$174.00		
EE77	9T18Y4506G79	\$2601.00	9T18Y4502G79	\$418.00	9T18Y4505G79	\$512.00	9T18Y4501G79	\$244.00		

Not User Replaceable
Contact Technical Support

²Enclosure Kit Contains 2 Front/Backs, 2 Sides, 1 Cover

Enclosure Parts for QL Transformers

Frame Size	Rainshield Kit		Wall Mount Kit	
	Product No.	List Price	Product No.	List Price
EE71	9T18Y4317G11	\$256.00	9T18Y5042	\$141.00
EE72	9T18Y4317G05	\$256.00	9T18Y5042	\$141.00
EE73	9T18Y4317G05	\$256.00	9T18Y5042	\$141.00
EE74	9T18Y4317G06	\$256.00	9T18Y5043	\$196.00
EE75	9T18Y4317G06	\$256.00	N/A	N/A
EE76	9T18Y4317G07	\$359.00	N/A	N/A
EE77	9T18Y4322G79	\$359.00	N/A	N/A

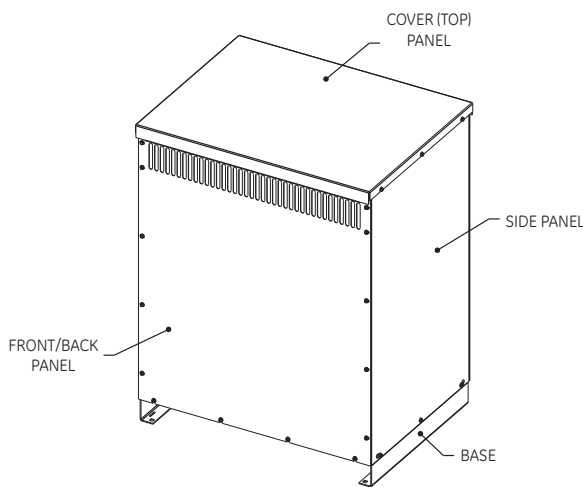

ENCLOSURE KIT: 1 COVER + 2 SIDES + 2 FRONTS

QL Style Enclosure

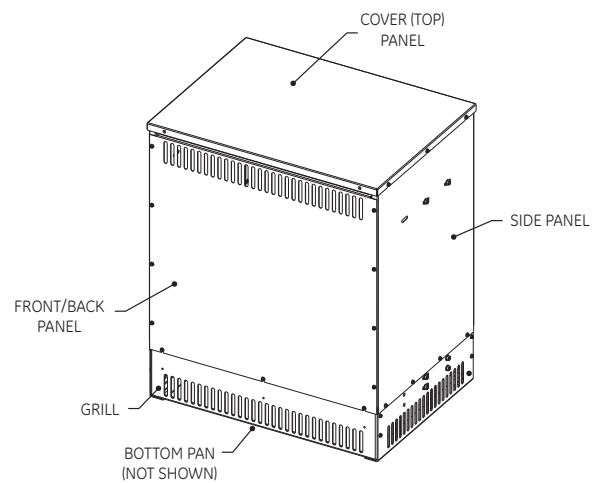

ENCLOSURE KIT: 1 COVER + 2 SIDES + 2 FRONTS

TransforMore® Style Enclosure



Publications and Reference: See Section 22 for a complete list of additional product-related publications

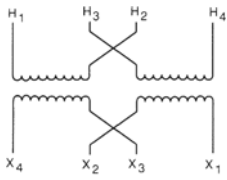

Diagram 1

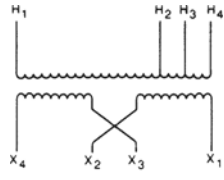

Diagram 2

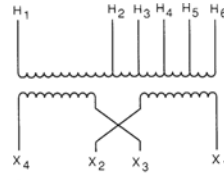

Diagram 3

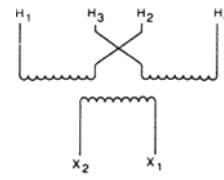

Diagram 4

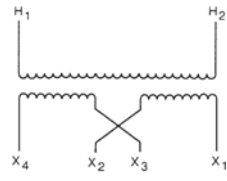

Diagram 5

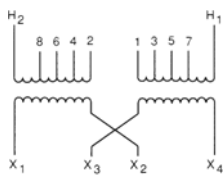

Diagram 6

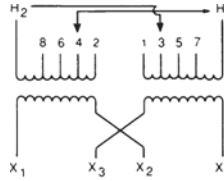

Diagram 7

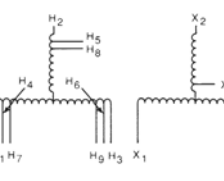

Diagram 8

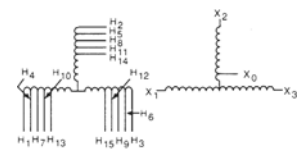

Diagram 9

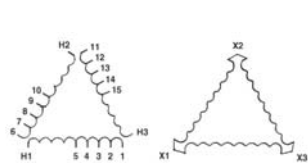

Diagram 10

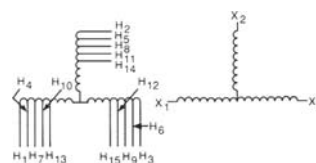

Diagram 11

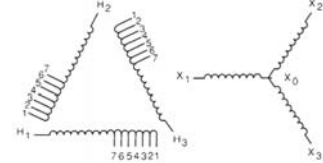

Diagram 12

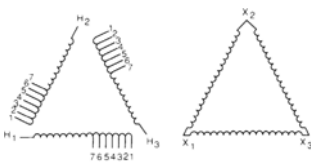

Diagram 13

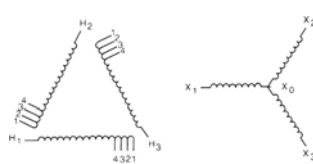

Diagram 14

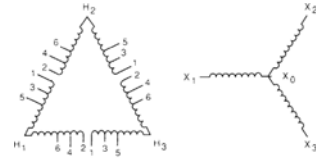

Diagram 15

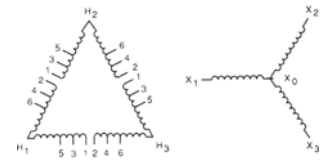

Diagram 16

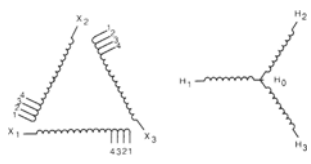

Diagram 17

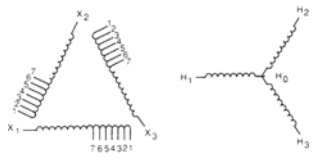

Diagram 18

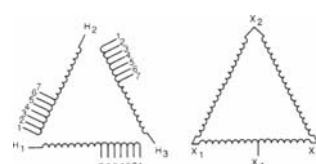

Diagram 19

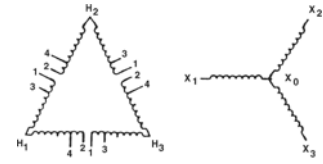

Diagram 20

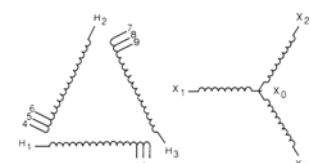

Diagram 21

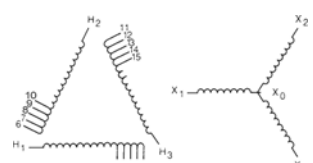

Diagram 22

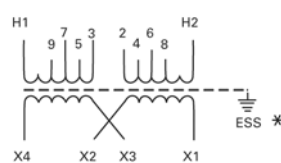

Diagram 23

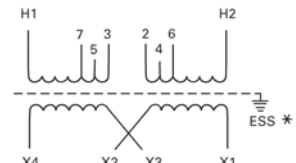

Diagram 24



1-Phase Vented QL Transformers

Frame Size	Outline Drawing No.	Height (In.)	Width (In.)	Depth (In.)
E171	303B406AAP071	32.1	23.8	18.4
E172	303B406AAP072	35.7	31.8	24
E173	303B406AAP073	35.7	31.8	24

3-Phase, Vented, Non-Fan Cooled QL Transformers (9T8-models)

Includes General Purpose, K-Factor, K-Factor Low Noise, Low Noise, Guard II, Midtapped, and Drive Isolation

Frame Size	Outline Drawing	Height (in.)	Width (In.)	Depth (In.)
EE71	303B401AAP071	27.3	18.7	16.9
EE72	303B401AAP072	32.1	23.8	18.4
EE73	303B401AAP073	32.2	23.8	18.4
EE74	303B401AAP074	35.7	31.8	24
EE75	303B401AAP075	39.9	31.8	24
EE76	303B401AAP076	45.9	34.8	24
EE77	303B919AAP077	45.5	38.4	33

3-Phase Fan-Cooled TransforMore® Transformers (9T4-models)

Includes General Purpose, K-Factor, K-Factor Low Noise, Low Noise, Guard II, Midtapped, and Drive Isolation

Frame Size	Outline Drawing	Height (in.)	Width (In.)	Depth (In.)
FC77	303B899AAP077	37.3	29.5	28.5
FC78	303B899AAP078	40.9	34.8	25.6
FC79	303B899AAP079	45.4	38.5	33.6
FC67	303B899AAP067	57.5	47.5	40
FC68	303B899AAP068	57.5	47.5	40

Servicenter Transformers

Frame Size	Outline Drawing	Height (in.)	Width (In.)	Depth (In.)
16350	303B915AAP005	32.5	10.75	11.12
16600	303B915AAP007	32.5	10.75	11.12
19400	303B915AAP010	35	12.62	12.62
19500	303B915AAP015	35	12.62	12.62
50500	303B915AAP025	44.75	16.75	16
EE71	303B404AAP015	27.3	27.4	16.9
EE72	303B404AAP022	32.2	34.5	24
EE72	303B404AAP030	32.2	34.5	24

QMS Transformers

Frame Size	Outline Drawing	Height (in.)	Width (In.)	Depth (In.)
16350	303B923AAP005	14.5	10.62	11
16400	303B923AAP005	14.5	10.62	11
16450	303B923AAP005	14.5	10.62	11
16600	303B923AAP007	17.06	10.62	11
19400	303B923AAP010	17.06	12.5	12.5
19450	303B923AAP010	17.06	12.5	12.5
19500	303B915AAP015	35	12.62	12.62
1619	303B922AAP001	14.50	10.75	11.12
1620	303B922AAP001	14.50	10.75	11.12
1921	303B922AAP003	17.12	12.62	12.75
1923	303B922AAP004	18.81	14.75	14.53
50500	303B915AAP025	44.75	16.75	16



QL Transformer
(Front Panel Removed)



TransforMore® Transformer

Guard II Transformers

Frame Size	Outline Drawing No.	Height (In.)	Width (In.)	Depth (In.)
EE71	303B403AAP071	34.5	18.7	16.9
EE72	303B403AAP072	41.3	23.8	18.4
EE73	303B403AAP073	41.3	23.8	18.4
EE74	303B403AAP074	44.8	31.8	24
EE75	303B403AAP075	49.1	31.8	24

TENV Transformers

Frame Size	Outline Drawing No.	Height (In.)	Width (In.)	Depth (In.)
EE72	303B405AAP072	41.3	23.8	18.4
EE73	303B405AAP073	41.3	23.8	18.4
EE74	303B405AAP074	44.8	31.8	24
EE75	303B405AAP075	49.1	31.8	24

QB Transformers

Frame Size	Outline Drawing No.	Height (In.)	Width (In.)	Depth (In.)
6100	303B920AAP001	6.38	5.12	3.25
6150	303B920AAP001	6.38	5.12	3.25
6200	303B920AAP001	6.38	5.12	3.25
8175	303B920AAP002	7.38	6.12	4.25
8200	303B920AAP002	7.38	6.12	4.25
10200	303B920AAP003	8.38	6.88	4.88
10225	303B920AAP003	8.38	6.88	4.88
12200	303B920AAP004	9.62	7.88	5.5
12225	303B920AAP004	9.62	7.88	5.5
12275	303B920AAP004	9.62	7.88	5.5
12300	303B920AAP004	9.62	7.88	5.5
14200	303B920AAP005	11.12	9.38	6.72
14225	303B920AAP005	11.12	9.38	6.72
14250	303B920AAP005	11.12	9.38	6.72
14300	303B920AAP005	11.12	9.38	6.72
14350	303B920AAP005	11.12	9.38	6.72
14400	303B920AAP005	11.12	9.38	6.72



Publications and Reference: See Section 22 for a complete list of additional product-related publications

Transformers

Typical Transformer Performance Data

General Purpose

Aluminum

Section 8

480V Delta to 208/120V Wye TP1 Transformers

kVA	Rise (°C)	Product No.	Losses in Watts		Efficiency					% Regulation				Dimensions (In.)			Wt. Lbs.	dB	Outline Drawing			
			N.L.	Total	.25L	.35L	.50L	.75L	Full L	1.0 PF	.8 PF	%R	%X	% Z	X/R	HT				W	D	
15	150	9T83B3871	150	1154						97.0	5.1	6.1	5.1	3.3	6.1	0.6	27.3	18.7	16.9	265	45	303B401AAP071
15	115	9T83B3871G15	150	1063						97.0	5.1	6.1	5.1	3.3	6.1	0.6	27.3	18.7	16.9	265	45	303B401AAP071
15	80	9T83B3871G80	150	980						97.0	5.1	6.1	5.1	3.3	6.1	0.6	27.3	18.7	16.9	265	45	303B401AAP071
30	150	9T83B3872	207.0	1530.0						97.5	3.8	5.5	3.7	4.2	5.6	1.1	32.2	23.8	18.4	375	45.0	303B401AAP072
30	115	9T83B3872G15	207.0	1410.0						97.5	3.9	5.9	3.7	4.2	5.6	1.1	32.2	23.8	18.4	375	45.0	303B401AAP072
30	80	9T83B3872G80	267.0	953.0						97.5	2.1	3.3	2.1	2.7	3.4	1.3	32.2	23.8	18.4	430	45.0	303B401AAP073
45	150	9T83B3873	267.0	2078.0						97.7	3.4	5.1	3.5	4.1	5.4	1.2	32.2	23.8	18.4	430	45.0	303B401AAP073
45	115	9T83B3873G15	267.0	1913.0						97.7	3.4	5.1	3.5	4.1	5.4	1.2	32.2	23.8	18.4	430	45.0	303B401AAP073
45	80	9T83B3873G80	387.0	1207.0						97.7	1.6	3.3	1.6	3.4	3.7	2.1	35.7	31.8	24	600	50.0	303B401AAP074
75	150	9T83B3874	387.0	3016.0						98.0	3.0	5.7	2.9	5.6	6.4	1.9	35.7	31.8	24	600	50.0	303B401AAP074
75	115	9T83B3874G15	387.0	2777.0						98.0	3.0	5.7	2.9	5.6	6.4	1.9	35.7	31.8	24	600	50.0	303B401AAP074
75	80	9T83B3874G80	504.0	2121.0						98.0	2.0	3.5	1.9	3.1	3.7	1.6	39.9	31.8	24	760	50.0	303B401AAP075
112.5	150	9T83B3875	504.0	4564.0						98.3	3.4	5.5	3.3	4.7	5.8	1.4	39.9	31.8	24	760	50.0	303B401AAP075
112.5	115	9T83B3875G15	504.0	4064.0						98.2	3.0	5.5	2.8	5.3	6.0	1.9	39.9	31.8	24	760	50.0	303B401AAP075
112.5	80	9T40G0005G81	400.0	2420.0	98.2	98.4	98.4	98.3	97.9	1.8	2.7	1.8	2.2	2.8	1.2	37.3	29.5	28.5	845	54.0	303B899AAP077	
150	150	9T40G0006	400.0	3987.0	98.5	98.6	98.3	98.1	97.5	2.4	4.2	2.4	3.7	4.4	1.5	37.3	29.5	28.5	845	54.0	303B899AAP077	
150	115	9T40G0006G51	400.0	3987.0	98.5	98.6	98.3	98.1	97.5	2.4	4.2	2.4	3.7	4.4	1.5	37.3	29.5	28.5	845	54.0	303B899AAP077	
150	80	9T40G0006G81	400.0	3987.0	98.5	98.6	98.3	98.1	97.5	2.4	4.2	2.4	3.7	4.4	1.5	37.3	29.5	28.5	845	54.0	303B899AAP077	
225	150	9T40G0007	400.0	10400.0	98.6	98.5	98.0	97.1	95.7	4.3	6.9	4.3	5.6	7.0	1.3	37.3	29.5	28.5	845	54.0	303B899AAP077	
225	115	9T40G0007G51	500.0	5950.0	98.7	98.7	98.4	98.1	97.5	2.4	4.9	2.4	5.0	5.5	1.9	40.9	34.8	25.6	1020	53.0	303B899AAP078	
225	80	9T40G0007G81	500.0	6450.0	98.6	98.6	98.3	98.0	97.3	2.6	5.1	2.6	4.9	5.6	1.9	40.9	34.8	25.6	1020	54.0	303B899AAP078	
300	150	9T40G0008	500.0	12430.0	98.7	98.6	98.1	97.3	96.1	4.0	6.9	4.0	6.2	7.4	1.6	40.9	34.8	25.6	1020	54.0	303B899AAP078	
300	115	9T40G0008G51	740.0	6040.0	98.6	98.8	98.6	98.5	98.1	1.8	4.5	1.8	5.2	5.5	2.9	45.4	38.5	33.6	1585	54.0	303B899AAP079	
300	80	9T40G0008G81	740.0	6040.0	98.6	98.8	98.6	98.5	98.1	1.8	4.5	1.8	5.2	5.5	2.9	45.4	38.5	33.6	1585	54.0	303B899AAP079	
500	150	9T40G0009	740.0	15680.0	98.9	98.8	98.4	97.9	97.0	3.0	7.5	3.0	7.5	8.0	2.5	45.4	38.5	33.6	1585	54.0	303B899AAP079	
500	115	9T40G0009G51	1395.0	7300.0	98.6	98.9	98.8	98.8	98.6	1.2	3.8	1.2	4.7	4.9	3.9	57.5	47.5	40	3250	56.0	303B899AAP067	
500	80	9T40G0009G81	1395.0	7300.0	98.6	98.9	98.8	98.8	98.6	1.2	3.8	1.2	4.7	4.9	3.9	57.5	47.5	40	3250	56.0	303B899AAP067	
750	150	9T40G0010	1395.0	15400.0	98.9	99.0	98.8	98.5	98.0	1.9	4.8	1.9	5.5	5.8	2.9	57.5	47.5	40	3250	56.0	303B899AAP067	
750	115	9T40G0010G51	1395.0	13400.0	98.9	99.0	98.9	98.7	98.3	1.6	5.8	1.6	7.5	7.6	4.7	57.5	47.5	40	3250	56.0	303B899AAP067	
1000	150	9T40G0011	1395.0	24850.0	99.0	99.0	98.8	98.4	97.6	2.3	7.8	2.3	9.8	10.0	4.3	57.5	47.5	40	3250	56.0	303B899AAP068	



Transformers

Typical Transformer Performance Data

General Purpose

Copper

Copper 480V Delta to 208/120V Wye TP1 Transformers

kVA	Rise (°C)	Product No.	Losses in Watts		Efficiency					% Regulation			Dimensions (In.)			Wt. Lbs.	dB	Outline Drawing			
			N.L.	Total	.25L	.35L	.50L	.75L	Full L	1.0 PF	.8 PF	%R	%X	%Z	X/R				HT	W	D
15	150	9T83C9871	167	912	96.8	97.0	97.2	96.7	95.9	4.4	4.8	4.3	2.2	4.8	0.5	27.3	18.7	16.9	290	45.0	303B401AAP071
15	115	9T83C9871G15	167	848	96.8	97.0	97.2	96.7	95.9	4.4	4.8	4.3	2.2	4.8	0.5	27.3	18.7	16.9	290	45.0	303B401AAP071
15	80	9T83C9871G80	207	420		97.0				1.3	2.3	1.3	2.1	2.5	1.6	32.2	23.8	18.4	435	45.0	303B401AAP072
30	150	9T83C9872	230	1120	97.3	97.5	97.8	97.7	97.3	2.7	4.6	2.8	4.3	5.1	1.8	32.2	23.8	18.4	435	45.0	303B401AAP072
30	115	9T83C9872G15	230	1043	97.3	97.5	97.8	97.7	97.3	2.7	4.6	2.8	4.3	5.1	1.8	32.2	23.8	18.4	435	45.0	303B401AAP072
30	80	9T83C9872G80	267	882		97.5				1.9	2.9	1.9	2.3	3.0	1.2	32.2	23.8	18.4	510	45.0	303B401AAP073
45	150	9T83C9873	297	1796	97.5	97.7	97.9	97.6	97.1	3.0	4.5	3.0	3.5	4.6	1.2	32.2	23.8	18.4	510	45.0	303B401AAP073
45	115	9T83C9873G15	297	1667	97.5	97.7	97.9	97.6	97.1	3.0	4.5	3.0	3.5	4.6	1.2	32.2	23.8	18.4	510	45.0	303B401AAP073
45	80	9T83C9873G80	387	1140		97.7				1.4	2.7	1.4	2.6	2.9	1.9	35.7	31.8	24	730	50.0	303B401AAP074
75	150	9T83C9874	430	2658	97.9	98.0	98.2	97.9	97.5	2.7	4.7	2.7	4.3	5.1	1.7	35.7	31.8	24	730	50.0	303B401AAP074
75	115	9T83C9874G15	430	2466	97.9	98.0	98.2	97.9	97.5	2.7	4.7	2.7	4.3	5.1	1.7	35.7	31.8	24	730	50.0	303B401AAP074
75	80	9T83C9874G80	504	2121		98.0				2.0	3.5	1.9	3.1	3.7	1.6	39.9	31.8	24	820	50.0	303B401AAP075
112.5	150	9T83C9875	560	3344	98.1	98.2	98.4	98.2	97.8	2.2	4.5	2.1	4.6	5.1	2.2	39.9	31.8	24	820	50.0	303B401AAP075
112.5	115	9T83C9875G15	560	3105	98.1	98.2	98.4	98.2	97.8	2.2	4.5	2.1	4.6	5.1	2.2	39.9	31.8	24	820	50.0	303B401AAP075
112.5	80	9T45G0005G81	400	2100	98.3	98.5	98.5	98.5	98.2	1.5	2.3	1.5	1.9	2.4	1.3	37.3	29.5	28.5	976	54.0	303B899AAP077
150	150	9T45G0006	400	3430	98.5	98.7	98.5	98.3	97.8	2.0	3.5	2.0	3.1	3.7	1.6	37.3	29.5	28.5	976	54.0	303B899AAP077
150	115	9T45G0006G51	400	3430	98.5	98.7	98.5	98.3	97.8	2.0	3.5	2.0	3.1	3.7	1.6	37.3	29.5	28.5	976	54.0	303B899AAP077
150	80	9T45G0006G81	400	3425	98.5	98.7	98.5	98.3	97.8	2.0	3.5	2.0	3.1	3.7	1.6	37.3	29.5	28.5	976	54.0	303B899AAP077
225	150	9T45G0007	400	8770	98.7	98.6	98.2	97.5	96.3	3.7	5.7	3.7	4.6	5.9	1.2	37.3	29.5	28.5	976	54.0	303B899AAP077
225	115	9T45G0007G51	500	4970	98.7	98.8	98.6	98.4	97.9	2.0	3.8	2.0	3.8	4.3	1.9	40.9	34.8	25.6	1160	54.0	303B899AAP078
225	80	9T45G0007G81	500	4970	98.7	98.8	98.6	98.4	97.9	2.0	3.8	2.0	3.8	4.3	1.9	40.9	34.8	25.6	1160	54.0	303B899AAP078
300	150	9T45G0008	500	10270	98.8	98.7	98.3	97.8	96.7	3.3	5.3	3.3	4.6	5.7	1.4	40.9	34.8	25.6	1160	54.0	303B899AAP078
300	115	9T45G0008G51	740	5540	98.7	98.8	98.7	98.6	98.2	1.6	3.2	1.6	3.2	3.5	2.0	45.4	38.5	33.6	1700	54.0	303B899AAP079
300	80	9T45G0008G81	740	5540	98.7	98.8	98.7	98.6	98.2	1.6	3.2	1.6	3.2	3.5	2.0	45.4	38.5	33.6	1700	54.0	303B899AAP079
500	150	9T45G0009	740	14150	98.9	98.9	98.6	98.1	97.3	2.7	5.4	2.7	5.2	5.8	1.9	45.4	38.5	33.6	1700	54.0	303B899AAP079
500	115	9T45G0009G51	740	14150	98.9	98.9	98.6	98.1	97.3	2.7	5.4	2.7	5.2	5.8	1.9	45.4	38.5	33.6	1700	54.0	303B899AAP079
500	80	9T45G0009G81	1395	5950	98.7	98.8	99.0	99.0	98.8	0.9	2.0	0.9	2.1	2.3	2.3	57.5	47.5	40	4030	56.0	303B899AAP067
750	150	9T45G0010	1395	11300	99.0	99.1	99.0	98.9	98.5	1.3	3.7	1.3	4.4	4.6	3.4	57.5	47.5	40	4030	56.0	303B899AAP067
750	115	9T45G0010G51	1395	11300	99.0	99.1	99.0	98.9	98.5	1.3	3.7	1.3	4.4	4.6	3.4	57.5	47.5	40	4030	56.0	303B899AAP067
750	80	9T45G0010G81	1395	11300	99.0	99.1	99.0	98.9	98.5	1.3	3.7	1.3	4.4	4.6	3.4	57.5	47.5	40	4030	56.0	303B899AAP067
1000	150	9T45G0011	1395	22500	99.1	99.1	98.9	98.5	97.8	2.1	6.1	2.1	7.3	7.6	3.5	57.5	47.5	40	4030	56.0	303B899AAP068



Publications and Reference: See Section 22 for a complete list of additional product-related publications

Transformers

Typical Transformer Performance Data

K-Factor

Aluminum

Section 8

480V Delta to 208/120V Wye Al Wound K Factor = 4 Transformers

K Factor	kVA	Rise (°C)	Product No.	Losses In Watts		Efficiency					% Regulation				Dimensions (In.)			Wt. Lbs.	dB	Outline Drawing			
				N.L.	Total	.25L	.35L	.50L	.75L	Full	1.0 PF	.8 PF	%R	%X	% Z	X/R	Ht				W	D	
4	15	150	9T83B3461G03	150	1154			97.0				5.1	6.1	5.1	3.3	6.1	0.6	27.3	18.7	16.9	265	45	303B401AAP071
4	15	115	9T83B3461G13	207	525			97.5				1.7	2.6	1.7	2.1	2.7	1.2	32.2	23.8	18.4	375	45	303B401AAP072
4	15	80	9T83B3461G83	207	496			97.5				1.7	2.6	1.7	2.1	2.7	1.2	32.2	23.8	18.4	375	45	303B401AAP072
4	30	150	9T83B3462G03	207	1530			97.5				3.8	5.5	3.9	4.4	5.9	1.1	32.2	23.8	18.4	375	45	303B401AAP072
4	30	115	9T83B3462G13	267	1070			97.5				2.3	3.7	1.9	2.9	3.4	1.5	32.2	23.8	18.4	430	45	303B401AAP073
4	30	80	9T83B3462G83	267	998			97.5				2.3	3.7	1.9	2.9	3.4	1.5	32.2	23.8	18.4	430	45	303B401AAP073
4	45	150	9T83B3463G03	267	2078			97.7				3.4	5.1	4.0	4.6	6.1	1.2	32.2	23.8	18.4	430	45	303B401AAP073
4	45	115	9T83B3463G13	387	1289			97.7				1.6	3.3	1.7	3.7	4.0	2.2	35.7	31.8	24	600	50	303B401AAP074
4	45	80	9T83B3463G83	387	1207			97.7				1.6	3.3	1.7	3.7	4.0	2.2	35.7	31.8	24	600	50	303B401AAP074
4	75	150	9T83B3464G03	387	3016			98.0				3.0	5.7	3.2	6.1	7.0	1.9	35.7	31.8	24	600	50	303B401AAP074
4	75	115	9T83B3464G13	504	2283			98.0				2.0	3.5	2.1	3.4	4.1	1.6	39.9	31.8	24	760	50	303B401AAP075
4	75	80	9T83B3464G83	720	1870			98.0				1.4	2.7	1.6	3.0	3.5	1.9	45.9	34.8	24	904	50	303B401AAP076
4	112.5	150	9T44G0005G03	400	2420	98.2	98.4	98.4	98.3	97.9	1.8	2.7	1.6	2.0	2.5	1.3	37.3	29.5	28.5	845	54	303B899AAP077	
4	112.5	115	9T44G0005G53	400	2420	98.2	98.4	98.4	98.3	97.9	1.8	2.7	1.6	2.0	2.5	1.3	37.3	29.5	28.5	845	54	303B899AAP077	
4	112.5	80	9T44G0005G83	400	2420	98.2	98.4	98.4	98.3	97.9	1.8	2.7	1.6	2.0	2.5	1.3	37.3	29.5	28.5	845	54	303B899AAP077	
4	150	150	9T44G0006G03	400	3990	98.5	98.6	98.3	98.1	97.5	2.4	4.2	2.1	3.2	3.8	1.5	37.3	29.5	28.5	845	54	303B899AAP077	
4	150	115	9T44G0006G53	400	3990	98.5	98.6	98.3	98.1	97.5	2.4	4.2	2.1	3.2	3.8	1.5	37.3	29.5	28.5	845	54	303B899AAP077	
4	150	80	9T44G0006G83	400	3990	98.5	98.6	98.3	98.1	97.5	2.4	4.2	2.1	3.2	3.8	1.5	37.3	29.5	28.5	845	54	303B899AAP077	
4	225	150	9T44G0007G03	500	6450	98.6	98.6	98.3	98.0	97.3	2.6	5.1	2.9	5.4	6.2	1.9	40.9	34.8	25.6	1020	54	303B899AAP078	
4	225	115	9T44G0007G53	500	6450	98.6	98.6	98.3	98.0	97.3	2.6	5.1	2.9	5.4	6.2	1.9	40.9	34.8	25.6	1020	54	303B899AAP078	
4	225	80	9T44G0007G83	500	6450	98.6	98.6	98.3	98.0	97.3	2.6	5.1	2.9	5.4	6.2	1.9	40.9	34.8	25.6	1020	54	303B899AAP078	
4	300	150	9T44G0008G03	740	6040	98.6	98.8	98.6	98.5	98.1	1.8	4.5	1.8	5.2	5.5	2.9	45.4	38.5	33.6	1585	54	303B899AAP079	
4	300	115	9T44G0008G53	740	6040	98.6	98.8	98.6	98.5	98.1	1.8	4.5	1.8	5.2	5.5	2.9	45.4	38.5	33.6	1585	54	303B899AAP079	
4	300	80	9T44G0008G83	740	6040	98.6	98.8	98.6	98.5	98.1	1.8	4.5	1.8	5.2	5.5	2.9	45.4	38.5	33.6	1585	54	303B899AAP079	
4	500	150	9T44G0009G03	1395	8535	98.6	98.9	98.8	98.8	98.6	1.2	3.8	1.2	4.7	4.9	3.9	57.5	47.5	40	3250	56	303B899AAP068	
4	500	115	9T44G0009G53	1395	7885	98.6	98.9	98.8	98.8	98.6	1.2	3.8	1.2	4.7	4.9	3.9	57.5	47.5	40	3250	56	303B899AAP068	
4	500	80	9T44G0009G83	1395	7300	98.6	98.9	98.8	98.8	98.6	1.2	3.8	1.2	4.7	4.9	3.9	57.5	47.5	40	3250	56	303B899AAP068	
4	750	150	9T44G0010G03	1395	14600	98.9	99.0	98.9	98.7	98.3	1.6	5.8	1.6	7.5	7.6	4.7	57.5	47.5	40	3250	56	303B899AAP068	
4	750	115	9T44G0010G53	1395	13365	97.7	98.1	98.2	98.3	98.0	1.6	5.8	1.6	7.5	7.6	4.7	57.5	47.5	40	3250	56	303B899AAP068	

480V Delta to 208/120V Wye Al Wound K Factor = 13 Transformers

K Factor	kVA	Rise (°C)	Product No.	Losses in Watts		Efficiency					% Regulation				Dimensions (in.)			Wt. Lbs.	dB	Outline Drawing			
				N.L.	Total	.25L	.35L	.50L	.75L	Full	1.0 PF	.8 PF	%R	%X	% Z	X/R	Ht				W	D	
13	15	150	9T83B3471G03	150	1154			97.0				5.1	6.1	5.1	3.3	6.1	0.6	27.3	18.7	16.9	265	45.0	303B401AAP071
13	15	115	9T83B3471G13	207	525			97.5				1.7	2.6	1.7	2.1	2.7	1.2	32.2	23.8	18.4	375	45.0	303B401AAP072
13	15	80	9T83B3471G83	207	496			97.5				1.7	2.6	1.7	2.1	2.7	1.2	32.2	23.8	18.4	375	45.0	303B401AAP072
13	30	150	9T83B3472G03	207	1530			97.5				3.8	5.5	3.9	4.4	5.9	1.1	32.2	23.8	18.4	375	45.0	303B401AAP072
13	30	115	9T83B3472G13	267	1070			97.5				2.3	3.7	1.9	2.9	3.4	1.5	32.2	23.8	18.4	430	45.0	303B401AAP073
13	30	80	9T83B3472G83	267	998			97.5				2.3	3.7	1.9	2.9	3.4	1.5	32.2	23.8	18.4	430	45.0	303B401AAP073
13	45	150	9T83B3473G03	267	2078			97.7				3.4	5.1	4.0	4.6	6.1	1.2	32.2	23.8	18.4	430	45.0	303B401AAP073
13	45	115	9T83B3473G13	387	1289			97.7				1.6	3.3	1.7	3.7	4.0	2.2	35.7	31.8	24	600	50.0	303B401AAP074
13	45	80	9T83B3473G83	504	1124			97.7				1.3	2.1	1	1.7	2	1.7	39.9	31.8	24	760	50	303B401AAP075
13	75	150	9T83B3474G03	504	2461			98.0				2.0	3.5	2.1	3.4	4.1	1.6	39.9	31.8	24	760	50.0	303B401AAP075
13	75	115	9T83B3474G13	504	2283			98.0				2.0	3.5	2.1	3.4	4.1	1.6	39.9	31.8	24	760	50.0	303B401AAP075
13	112.5	150	9T41G0005G03	400	2420	98.2	98.4	98.4	98.3	97.9	1.8	2.7	1.6	2.0	2.5	1.3	37.3	29.5	28.5	845	54.0	303B899AAP077	
13	112.5	115	9T41G0005G53	400	2420	98.2	98.4	98.4	98.3	97.9	1.8	2.7	1.6	2.0	2.5	1.3	37.3	29.5	28.5	845	54.0	303B899AAP077	
13	112.5	80	9T41G0005G83	400	2420	98.2	98.4	98.4	98.3	97.9	1.8	2.7	1.6	2.0	2.5	1.3	37.3	29.5	28.5	845	54.0	303B899AAP077	
13	150	150	9T41G0006G03	400	3990	98.5	98.6	98.3	98.1	97.5	2.4	4.2	2.1	3.2	3.8	1.5	37.3	29.5	28.5	845	54.0	303B899AAP077	
13	150	115	9T41G0006G53	400	3990	98.5	98.6	98.3	98.1	97.5	2.4	4.2	2.1	3.2	3.8	1.5	37.3	29.5	28.5	845	54.0	303B899AAP077	
13	150	80	9T41G0006G83	500	2630	98.4	98.7	98.7	98.6	98.3	1.7	3.0	1.8	2.9	3.4	1.6	40.9	34.8	25.6	1020	54.0	303B899AAP078	
13	225	150	9T41G0007G03	500	6450	98.6	98.6	98.3	98.0	97.3	2.6	5.1	2.9	5.4	6.2	1.9	40.9	34.8	25.6	1020	54.0	303B899AAP078	
13	225	115	9T41G0007G53	500	6450	98.6	98.6	98.3	98.0	97.3	2.6	5.1	2.9	5.4	6.2	1.9	40.9	34.8	25.6	1020	54.0	303B899AAP078	
13	225	80	9T41G0007G83	740	3740	98.4	98.7	98.6	98.6	98.4	1.3	3.4	1.2	3.4	3.6	2.8	45.4	38.5	33.6	1585	54.0	303B899AAP079	
13	300	150	9T41G0008G03	740	6040	98.6	98.8	98.6	98.5	98.1	1.8	4.5	1.8	5.2	5.5	2.9	45.4	38.5	33.6	1585	54.0	303B899AAP079	
13	300	115	9T41G0008G53	1395	3705	98.0	98.5	98.7	98.9	98.9	0.6	1.9	0.6	2.4	2.1	4.0	57.5	47.5	40	3250	56.0	303B899AAP068	
13	300	80	9T41G0008G83	1395	3495	98.0	98.5	98.7	98.9	98.9	0.6	1.9	0.6	2.4	2.1	4.0	57.5	47.5	40	3250	56.0	303B899AAP068	
13	500	150	9T41G0009G03	1395	8535	98.6	98.9	98.8	98.8	98.6	1.2	3.8	1.2	4.7	4.9	3.9	57.5	47.5	40	3250	56.0	303B899AAP068	



Transformers

Typical Transformer Performance Data

K-Factor

Copper

Copper 480V Delta to 208/120V Wye K Factor = 4 Transformers

K Factor	kVA	Rise (°C)	Product No.	Losses in Watts		Efficiency					% Regulation		%R	%X	%Z	X/R	Dimensions (in.)			Wt. Lbs.	dB	Outline Drawing
				N.L.	Total	.25L	.35L	.50L	.75L	Full	1.0 PF	.8 PF					Ht	W	D			
4	15	150	9T83C9461G03	167	911.7	96.8	97.0	97.2	96.7	95.9	4.4	4.8	4.3	2.2	4.8	0.5	27.3	18.7	16.9	290	45	303B401AAP071
4	15	115	9T83C9461G13	230	450.7	96.2	97.0	98.2	98.7	98.7	1.4	2.4	1.3	2.1	2.5	1.6	32.1	23.8	18.4	435	45	303B401AAP072
4	15	80	9T83C9461G83	230	429.8	96.2	97.0	98.2	98.7	98.9	1.3	2.3	1.3	2.1	2.5	1.6	32.1	23.8	18.4	435	45	303B401AAP072
4	30	150	9T83C9462G03	230	1119.6	97.3	97.5	97.8	97.7	97.3	2.7	4.6	2.8	4.3	5.1	1.5	32.1	23.8	18.4	435	45.0	303B401AAP072
4	30	115	9T83C9462G13	297	929.3	97.0	97.5	98.2	98.3	98.2	1.9	2.9	1.9	2.3	3.0	1.2	32.2	23.8	18.4	510	45.0	303B401AAP073
4	30	80	9T83C9462G83	297	869.3	97.0	97.5	98.2	98.3	98.2	1.9	2.9	1.9	2.3	3.0	1.2	32.2	23.8	18.4	510	45.0	303B401AAP073
4	45	150	9T83C9463G03	297	1795.8	97.5	97.7	97.9	97.6	97.1	3.0	4.5	3.0	3.5	4.6	1.2	32.2	23.8	18.4	510	45	303B401AAP073
4	45	115	9T83C9463G13	430	1206.1	97.2	97.7	98.4	98.6	98.5	1.7	2.8	1.5	2.6	3.0	1.7	35.7	31.8	24	730	50.0	303B401AAP074
4	45	80	9T83C9463G83	430	1132.5	97.2	97.7	98.4	98.6	98.5	1.5	2.8	1.5	2.6	3.0	1.7	35.7	31.8	24	730	50.0	303B401AAP074
4	75	150	9T83C9464G03	430	2657.9	97.9	98.0	98.2	97.9	97.5	2.7	4.7	2.7	4.3	5.1	1.6	35.7	31.8	24	730	50.0	303B401AAP074
4	75	115	9T83C9464G13	560	1749	97.7	98.0	98.5	98.6	98.5	1.5	3.0	1.5	3.1	3.4	2.1	39.9	31.8	24	820	50.0	303B899AAP075
4	75	80	9T83C9464G83	800	1694.6	97.2	98.0	99.2	99.7	99.8	1.2	2.2	1.1	2.1	2.4	1.9	45.9	34.8	24	965	50.0	303B401AAP076
4	112.5	150	9T83C9465G03	800	3085.6	97.8	98.2	98.9	99.0	98.9	1.8	3.3	1.8	3.2	3.7	1.8	45.9	34.8	24	965	50.0	303B401AAP076
4	112.5	115	9T49G0005G53	400	2100	98.3	98.5	98.5	98.5	98.2	1.5	2.3	1.5	2.0	2.5	1.3	37.3	29.5	28.5	976	54.0	303B899AAP077
4	112.5	80	9T49G0005G83	400	2100	98.3	98.5	98.5	98.5	98.2	1.5	2.3	1.5	2.0	2.5	1.3	37.3	29.5	28.5	976	54.0	303B899AAP077
4	150	150	9T49G0006G03	400	3425	98.5	98.7	98.5	98.3	97.8	2.0	3.5	2.1	3.3	3.9	1.6	37.3	29.5	28.5	976	54.0	303B899AAP077
4	150	115	9T49G0006G53	400	3425	98.5	98.7	98.5	98.3	97.8	2.0	3.5	2.1	3.3	3.9	1.6	37.3	29.5	28.5	976	54.0	303B899AAP077
4	150	80	9T49G0006G83	400	3425	98.5	98.7	98.5	98.3	97.8	2.0	3.5	2.1	3.3	3.9	1.6	37.3	29.5	28.5	976	54.0	303B899AAP077
4	225	150	9T49G0007G03	500	4970	98.7	98.8	98.6	98.4	97.9	2.0	3.8	2.2	4.0	4.5	1.8	40.9	34.8	25.6	1160	54.0	303B899AAP078
4	225	115	9T49G0007G53	500	4970	98.7	98.8	98.6	98.4	97.9	2.0	3.8	2.2	4.0	4.5	1.8	40.9	34.8	25.6	1160	54.0	303B899AAP078
4	225	80	9T49G0007G83	500	4970	98.7	98.8	98.6	98.4	97.9	2.0	3.8	2.2	4.0	4.5	1.8	40.9	34.8	25.6	1160	54.0	303B899AAP078
4	300	150	9T49G0008G03	740	5540	98.7	98.8	98.7	98.6	98.2	1.6	3.2	2.0	4.1	4.5	2.1	45.4	38.5	33.6	1700	54.0	303B899AAP079
4	300	115	9T49G0008G53	740	5540	98.7	98.8	98.7	98.6	98.2	1.6	3.2	2.0	4.1	4.5	2.1	45.4	38.5	33.6	1700	54.0	303B899AAP079
4	300	80	9T49G0008G83	740	5540	98.7	98.8	98.7	98.6	98.2	1.6	3.2	2.0	4.1	4.5	2.1	45.4	38.5	33.6	1700	54.0	303B899AAP079
4	500	150	9T49G0009G03	1395	5950	98.7	98.9	99.0	99.0	98.8	0.9	2.0	1.4	3.2	3.6	2.3	57.5	47.5	40	4030	56.0	303B899AAP068
4	500	115	9T49G0009G53	1395	5950	98.7	98.9	99.0	99.0	98.8	0.9	2.0	1.4	3.2	3.6	2.3	57.5	47.5	40	4030	56.0	303B899AAP068
4	500	80	9T49G0009G83	1395	5950	98.7	98.9	99.0	99.0	98.8	0.9	2.0	1.4	3.2	3.6	2.3	57.5	47.5	40	4030	56.0	303B899AAP068
4	750	150	9T49G0010G03	1395	11300	99.0	99.1	99.0	98.9	98.5	1.3	3.7	1.3	4.4	4.6	3.4	57.5	47.5	40	4030	56.0	303B899AAP068
4	750	115	9T49G0010G53	1395	11300	99.0	99.1	99.0	98.9	98.5	1.3	3.7	1.3	4.4	4.6	3.4	57.5	47.5	40	4030	56.0	303B899AAP068

Copper 480V Delta to 208/120V Wye K Factor = 13 Transformers

K Factor	kVA	Rise (°C)	Product No.	Losses in Watts		Efficiency					% Regulation		%R	%X	%Z	X/R	Dimensions (in.)			Wt. Lbs.	dB	Outline Drawing
				N.L.	Total	.25L	.35L	.50L	.75L	Full	1.0 PF	.8 PF					Ht	W	D			
13	15	150	9T83C9471G03	167	911.7	96.8	97.0	97.2	96.7	95.9	4.4	4.8	4.3	2.2	4.8	0.5	27.3	18.7	16.9	290	45.0	303B401AAP071
13	15	115	9T83C9471G13	230	450.7	96.2	97.0	98.2	98.7	98.7	1.4	2.4	1.3	2.1	2.5	1.6	32.1	23.8	18.4	435	45.0	303B401AAP072
13	15	80	9T83C9471G83	230	429.8	96.2	97.0	98.2	98.7	98.9	1.3	2.3	1.3	2.1	2.5	1.6	32.1	23.8	18.4	435	45.0	303B401AAP072
13	30	150	9T83C9472G03	230	1119.6	97.3	97.5	97.8	97.7	97.3	2.7	4.6	2.8	4.3	5.1	1.5	32.1	23.8	18.4	435	45.0	303B401AAP072
13	30	115	9T83C9472G13	297	929.3	97.0	97.5	98.2	98.3	98.2	1.9	2.9	1.9	2.3	3.0	1.2	32.2	23.8	18.4	510	45.0	303B401AAP073
13	30	80	9T83C9472G83	297	869.3	97.0	97.5	98.2	98.3	98.2	1.9	2.9	1.9	2.3	3.0	1.2	32.2	23.8	18.4	510	45.0	303B401AAP073
13	45	150	9T83C9473G03	430	1279.1	97.2	97.7	98.4	98.6	98.5	1.5	2.8	1.5	2.6	3.0	1.7	35.7	31.8	24	730	50.0	303B401AAP074
13	45	115	9T83C9473G13	430	1206.1	97.2	97.7	98.4	98.6	98.5	1.5	2.8	1.5	2.6	3.0	1.7	35.7	31.8	24	730	50.0	303B401AAP074
13	45	80	9T83C9473G83	560	986.7	97.0	97.7	98.7	99.1	99.3	0.9	1.8	0.9	1.8	2.0	2.0	39.9	31.8	24	820	50.0	303B401AAP075
13	75	150	9T83C9474G03	560	1860.9	97.7	98.0	98.5	98.6	98.5	1.5	3.0	1.5	3.1	3.4	2.1	39.9	31.8	24	820	50.0	303B401AAP075
13	75	115	9T83C9474G13	560	1749	97.7	98.0	98.5	98.6	98.5	1.5	3.0	1.5	3.1	3.4	2.1	39.9	31.8	24	820	50.0	303B401AAP075
13	112.5	150	9T83C9475G03	800	3085.6	97.8	98.2	98.9	99.0	98.9	1.8	3.3	1.8	3.2	3.7	1.8	45.9	34.8	24	965	50.0	303B401AAP076
13	112.5	115	9T46G0005G53	400	2100	98.3	98.5	98.5	98.5	98.2	1.5	2.3	1.5	2.0	2.5	1.3	37.3	29.5	28.5	976	54.0	303B899AAP077
13	112.5	80	9T46G0005G83	400	2100	98.3	98.5	98.5	98.5	98.2	1.5	2.3	1.5	2.0	2.5	1.3	37.3	29.5	28.5	976	54.0	303B899AAP077
13	150	150	9T46G0006G03	400	3425	98.5	98.7	98.5	98.3	97.8	2.0	3.5	2.1	3.3	3.9	1.6	37.3	29.5	28.5	976	54.0	303B899AAP077
13	150	115	9T46G0006G53	400	3425	98.5	98.7	98.5	98.3	97.8	2.0	3.5	2.1	3.3	3.9	1.6	37.3	29.5	28.5	976	54.0	303B899AAP077
13	150	80	9T46G0006G83	500	2200	98.5	98.7	98.8	98.8	98.6	1.1	2.4	1.0	2.2	2.5	2.2	40.9	34.8	25.6	1160	54.0	303B899AAP078
13	225	150	9T46G0007G03	500	4970	98.7	98.8	98.6	98.4	97.9	2.0	3.8	2.2	4.0	4.5	1.8	40.9	34.8	25.6	1160	54.0	303B899AAP078
13	225	115	9T46G0007G53	500	4970	98.7	98.8	98.6	98.4	97.9	2.0	3.8	2.2	4.0	4.5	1.8	40.9	34.8	25.6	1160	54.0	303B899AAP078
13	225	80	9T46G0007G83	740	3440	98.4	98.7	98.7	98.7	98.5	1.2	2.4	1.4	2.6	3.0	1.9	45.4	38.5	33.6	1700	54.0	303B899AAP079
13	300	150	9T46G0008G03	740	5540	98.7	98.8	98.7	98.6	98.2	1.6	3.2	2.0	4.1	4.5	2.1	45.4	38.5	33.6	1700	54.0	303B899AAP079
13	300	115	9T46G0008G53	740	5540	98.7	98.8	98.7	98.6	98.2	1.6	3.2	2.0	4.1	4.5	2.1	45.4	38.5	33.6	1700	54.0	303B899AAP079
13	300	80	9T46G0008G83	1395	2995	98.1	98.5	98.8	99.0	99.0	0.5	1.2	0.6	1.6	1.7	2.7	57.5	47.5	40	4030	56.0	303B899AAP068
13	500	150	9T46G0009G03	1395	5950	98.7	98.9	99.0	99.0	98.8	0.9	2.0	1.4	3.2	3.6	2.3	57.5	47.5	40	4030	56.0	303B899AAP068
13	500	115	9T46G0009G53	1395	5950	98.7	98.9	99.0	99.0	98.8	0.9	2.0										

Transformers

General Purpose Encapsulated

Single-Phase NEMA 3R

Section 8

050 - 3 kVA Indoor/Outdoor Type QB UL Listed C-UL Listed

Input Voltage	Output Voltage	kVA	Frequency (Hz)	Taps	Wiring Diagram No. ¹	Weight (Lbs)	Frame Size	Product Number	List Price GO-90A
240 x 480 Volts, 480 Volts	120/240 Volts	0.05	60 Hz	No Taps	1	6	6100	9T5180002	\$82.00
240 x 480 Volts	120/240 Volts	0.05	50 Hz	No Taps	1	6	6100	9T5180502	\$88.00
240 x 480 Volts, 480 Volts	120/240 Volts	0.075	60 Hz	No Taps	1	6	6200	9T5180003	\$90.50
240 x 480 Volts	120/240 Volts	0.075	50 Hz	No Taps	1	6	6200	9T5180503	\$96.50
240 x 480 Volts, 480 Volts	120/240 Volts	0.1	60 Hz	No Taps	1	6	6200	9T5180004	\$98.50
240 x 480 Volts	120/240 Volts	0.1	50 Hz	No Taps	1	6	6200	9T5180504	\$104.00
240 x 480 Volts, 480 Volts	120/240 Volts	0.15	60 Hz	No Taps	1	10	8175	9T5180005	\$120.00
240 x 480 Volts	120/240 Volts	0.15	50 Hz	No Taps	1	10	8175	9T5180505	\$126.00
240 x 480 Volts, 480 Volts	120/240 Volts	0.25	60 Hz	No Taps	1	10	8175	9T5180007	\$141.00
240 x 480 Volts	120/240 Volts	0.25	50 Hz	No Taps	1	10	8200	9T5180507	\$149.00
240 x 480 Volts, 480 Volts	120/240 Volts	0.5	60 Hz	No Taps	1	16	10200	9T5180008	\$196.00
240 x 480 Volts	120/240 Volts	0.5	50 Hz	No Taps	1	20	10225	9T5180508	\$207.00
240 x 480 Volts, 480 Volts	120/240 Volts	0.75	60 Hz	No Taps	1	25	12200	9T5180009	\$254.00
240 x 480 Volts	120/240 Volts	0.75	50 Hz	No Taps	1	25	12225	9T5180509	\$269.00
240 x 480 Volts, 480 Volts	120/240 Volts	1	60 Hz	No Taps	1	25	12225	9T5180010	\$313.00
240 x 480 Volts	120/240 Volts	1	50 Hz	No Taps	1	30	12275	9T5180510	\$334.00
240 x 480 Volts, 480 Volts	120/240 Volts	1.5	60 Hz	No Taps	1	40	14200	9T5180011	\$382.00
240 x 480 Volts	120/240 Volts	1.5	50 Hz	No Taps	1	40	14225	9T5180511	\$407.00
240 x 480 Volts, 480 Volts	120/240 Volts	2	60 Hz	No Taps	1	45	14250	9T5180012	\$470.00
240 x 480 Volts	120/240 Volts	2	50 Hz	No Taps	1	50	14300	9T5180512	\$498.00
240 x 480 Volts, 480 Volts	120/240 Volts	3	60 Hz	No Taps	1	55	14350	9T5180013	\$582.00
240 x 480 Volts	120/240 Volts	3	50 Hz	No Taps	1	60	14400	9T5180513	\$615.00
480 Volts	120/240 Volts	0.5	50 Hz	(-2 5.0%)	2	20	10225	9T5180548	\$207.00
480 Volts	120/240 Volts	0.75	50 Hz	(-2 5.0%)	2	25	12200	9T5180549	\$269.00
480 Volts	120/240 Volts	1	60 Hz	(-2 5.0%)	2	25	12225	9T5180050	\$332.00
480 Volts	120/240 Volts	1	50 Hz	(-2 5.0%)	2	30	12275	9T5180550	\$334.00
480 Volts	120/240 Volts	1.5	60 Hz	(-2 5.0%)	2	40	14200	9T5180051	\$397.00
480 Volts	120/240 Volts	1.5	50 Hz	(-2 5.0%)	2	40	14225	9T5180551	\$407.00
480 Volts	120/240 Volts	2	60 Hz	(-2 5.0%)	2	45	14250	9T5180052	\$489.00
480 Volts	120/240 Volts	2	50 Hz	(-2 5.0%)	2	50	14300	9T5180552	\$498.00
480 Volts	120/240 Volts	3	60 Hz	(-2 5.0%)	2	55	14350	9T5180053	\$601.00
480 Volts	120/240 Volts	3	60 Hz	(+2,-2 2.5%)	3	55	14350	9T5180135	\$695.00
480 Volts	120/240 Volts	3	50 Hz	(-2 5.0%)	2	60	14400	9T5180553	\$615.00
600 Volts	120/240 Volts	0.05	60 Hz	No Taps	5	6	6100	9T5180082	\$85.00
600 Volts	120/240 Volts	0.075	60 Hz	No Taps	5	6	6200	9T5180083	\$94.50
600 Volts	120/240 Volts	0.1	60 Hz	No Taps	5	6	6200	9T5180084	\$102.00
600 Volts	120/240 Volts	0.1	50 Hz	No Taps	5	6	6200	9T5180584	\$108.00
600 Volts	120/240 Volts	0.15	60 Hz	No Taps	5	10	8175	9T5180085	\$123.00
600 Volts	120/240 Volts	0.25	60 Hz	No Taps	5	10	8175	9T5180087	\$154.00
600 Volts	120/240 Volts	0.25	50 Hz	No Taps	5	10	8200	9T5180587	\$164.00
600 Volts	120/240 Volts	0.5	60 Hz	No Taps	5	16	10200	9T5180088	\$204.00
600 Volts	120/240 Volts	0.5	50 Hz	(-2 5.0%)	2	20	10225	9T5180568	\$231.00
600 Volts	120/240 Volts	0.75	60 Hz	No Taps	5	25	12200	9T5180089	\$267.00
600 Volts	120/240 Volts	0.75	50 Hz	(-2 5.0%)	2	25	12200	9T5180569	\$294.00
600 Volts	120/240 Volts	1	60 Hz	(-2 5.0%)	2	25	12225	9T5180070	\$347.00
600 Volts	120/240 Volts	1	60 Hz	No Taps	5	25	12225	9T5180090	\$330.00
600 Volts	120/240 Volts	1	50 Hz	(-2 5.0%)	2	30	12275	9T5180570	\$361.00
600 Volts	120/240 Volts	1.5	60 Hz	(-2 5.0%)	2	40	14200	9T5180071	\$420.00
600 Volts	120/240 Volts	1.5	60 Hz	No Taps	5	40	14200	9T5180091	\$410.00
600 Volts	120/240 Volts	1.5	50 Hz	(-2 5.0%)	2	40	14225	9T5180571	\$445.00
600 Volts	120/240 Volts	2	60 Hz	(-2 5.0%)	2	45	14250	9T5180072	\$512.00
600 Volts	120/240 Volts	2	60 Hz	No Taps	5	45	14250	9T5180092	\$489.00
600 Volts	120/240 Volts	2	50 Hz	(-2 5.0%)	2	50	14300	9T5180572	\$542.00
600 Volts	120/240 Volts	2	50 Hz	No Taps	5	50	14300	9T5180592	\$527.00
600 Volts	120/240 Volts	3	60 Hz	(-2 5.0%)	2	55	14350	9T5180073	\$655.00
600 Volts	120/240 Volts	3	60 Hz	No Taps	5	55	14350	9T5180093	\$601.00
600 Volts	120/240 Volts	3	50 Hz	(-2 5.0%)	2	60	14400	9T5180573	\$693.00
600 Volts	120/240 Volts	3	50 Hz	No Taps	5	60	14400	9T5180593	\$674.00

¹See page 8-44 for wiring diagrams.



Transformers

General Purpose Encapsulated

Single-Phase NEMA 3R

.050 - 3 kVA Indoor/Outdoor Type QB UL Listed C-UL Listed

Input Voltage	Output Voltage	kVA	Frequency (Hz)	Taps	Wiring Diagram No. ¹	Weight (Lbs)	Frame Size	Product Number	List Price GO-90A
120 x 240 Volts	120/240 Volts	0.05	60 Hz	No Taps	1	6	6100	9T51B0022	\$93.50
120 x 240 Volts	120/240 Volts	0.1	60 Hz	No Taps	1	6	6200	9T51B0024	\$110.00
120 x 240 Volts	120/240 Volts	0.15	60 Hz	No Taps	1	10	8175	9T51B0025	\$137.00
120 x 240 Volts	120/240 Volts	0.25	60 Hz	No Taps	1	10	8175	9T51B0027	\$158.00
120 x 240 Volts	120/240 Volts	0.5	60 Hz	No Taps	1	16	10200	9T51B0028	\$221.00
120 x 240 Volts	120/240 Volts	0.75	60 Hz	No Taps	1	25	12200	9T51B0029	\$281.00
120 x 240 Volts	120/240 Volts	1	60 Hz	No Taps	1	25	12225	9T51B0030	\$355.00
120 x 240 Volts	120/240 Volts	1.5	60 Hz	No Taps	1	40	14200	9T51B0031	\$437.00
120 x 240 Volts	120/240 Volts	2	60 Hz	No Taps	1	45	14250	9T51B0032	\$533.00
120 x 240 Volts	120/240 Volts	3	60 Hz	No Taps	1	60	14400	9T51B0033	\$645.00
208 Volts	120/240 Volts	0.5	60 Hz	No Taps	4	16	10200	9T51B0158	\$218.00
208 Volts	120/240 Volts	0.75	60 Hz	No Taps	4	25	12200	9T51B0159	\$333.93
208 Volts	120/240 Volts	1	60 Hz	No Taps	4	25	12225	9T51B0160	\$303.00
208 Volts	120/240 Volts	2	60 Hz	No Taps	4	45	14250	9T51B0156	\$533.00
208 Volts	120/240 Volts	3	60 Hz	No Taps	4	55	14350	9T51B0157	\$645.00

.050 - 3 kVA Indoor/Outdoor Type QB UL Listed C-UL Listed

Input Voltage	Output Voltage	kVA	Frequency (Hz)	Taps	Wiring Diagram No. ¹	Weight (Lbs)	Frame Size	Product Number	List Price GO-90A
277 Volts	120/240 Volts	0.25	60 Hz	(-2 5.1%)	2	10	8175	9T51B0187	\$166.00
277 Volts	120/240 Volts	0.5	60 Hz	(-2 5.1%)	2	16	10200	9T51B0188	\$239.00
277 Volts	120/240 Volts	0.75	60 Hz	(-2 5.1%)	2	25	12200	9T51B0189	\$311.00
277 Volts	120/240 Volts	1	60 Hz	(-2 5.1%)	2	30	12275	9T51B0190	\$389.00
277 Volts	120/240 Volts	1.5	60 Hz	(-2 5.1%)	2	40	14200	9T51B0191	\$475.00
277 Volts	120/240 Volts	2	60 Hz	(-2 5.1%)	2	45	14250	9T51B0192	\$578.00
277 Volts	120/240 Volts	3	60 Hz	(-2 5.1%)	2	55	14350	9T51B0193	\$659.00
380/400/416 Volts	120/240 Volts	0.05	50 Hz	No Taps	2	6	6150	9T51B0162	\$97.50
380/400/416 Volts	120/240 Volts	0.15	50 Hz	No Taps	2	10	8175	9T51B0165	\$142.00
380/400/416 Volts	120/240 Volts	0.25	50 Hz	No Taps	2	10	8200	9T51B0167	\$164.00
380/400/416 Volts	120/240 Volts	0.5	50 Hz	No Taps	2	20	10225	9T51B0168	\$231.00
380/400/416 Volts	120/240 Volts	0.75	50 Hz	No Taps	2	25	12200	9T51B0169	\$302.00
380/400/416 Volts	120/240 Volts	1	50 Hz	No Taps	2	30	12275	9T51B0170	\$376.00
380/400/416 Volts	120/240 Volts	1.5	50 Hz	No Taps	2	40	14225	9T51B0171	\$464.00
380/400/416 Volts	120/240 Volts	2	50 Hz	No Taps	2	50	14300	9T51B0172	\$563.00
380/400/416 Volts	120/240 Volts	3	50 Hz	No Taps	2	60	14400	9T51B0173	\$645.00

¹See page 8-44 for wiring diagrams.



Publications and Reference: See Section 22 for a complete list of additional product-related publications

Transformers

General Purpose Encapsulated

Single-Phase NEMA 3R

Section 8

5 - 25 kVA Indoor/Outdoor Type QMS 115°C Rise UL Listed C-UL Listed

Input Voltage	Output Voltage	kVA	Frequency (Hz)	Taps	Wiring Diagram No. ¹	Weight (Lbs)	Frame Size	Product Number	List Price GO-90C
120 x 240 Volts	120/240 Volts	5	60 Hz	No Taps	1	103	16350	9T21B1001G02	\$964.00
120 x 240 Volts	120/240 Volts	7.5	60 Hz	No Taps	1	147	16600	9T21B1002G02	\$1342.00
120 x 240 Volts	120/240 Volts	10	60 Hz	No Taps	1	198	19400	9T21B1003G02	\$1712.00
120 x 240 Volts	120/240 Volts	10	60 Hz	No Taps	1	198	19400	9T21B1054G02	\$1,99.00
120 x 240 Volts	120/240 Volts	15	60 Hz	No Taps	1	220	19500	9T21B9101	\$2262.00
120 x 240 Volts	120/240 Volts	15	60 Hz	No Taps	1	233	19550	9T21B9131	\$2776.00
120 x 240 Volts	120/240 Volts	25	60 Hz	No Taps	1	333	19550	9T21B9102	\$3018.00
208 Volts	120/240 Volts	5	60 Hz	No Taps	4	103	16350	9T21B1028G02	\$964.00
208 Volts	120/240 Volts	7.5	60 Hz	No Taps	4	147	16600	9T21B1029G02	\$1342.00
208 Volts	120/240 Volts	10	60 Hz	No Taps	4	198	19400	9T21B1030G02	\$1712.00
208 Volts	120/240 Volts	15	60 Hz	No Taps	4	220	19500	9T21B9119	\$2262.00
208 Volts	120/240 Volts	25	60 Hz	No Taps	4	388	50500	9T21B9120	\$3018.00

¹See page 8-44 for wiring diagrams.

²For Outdoor NEMA 3R Enclosure add suffix G62 to product number.

5 - 25 kVA Indoor/Outdoor Type QMS 115°C Rise UL Listed C-UL Listed

Input Voltage	Output Voltage	kVA	Frequency (Hz)	Taps	Wiring Diagram No. ¹	Weight (Lbs)	Frame Size	Product Number	List Price GO-90C
277 Volts	120/240 Volts	5	60 Hz	(-2 5.1%)	2	103	16350	9T21B1046G02	\$964.00
277 Volts	120/240 Volts	5	60 Hz	(-2 2.5%)	2	103	16350	9T21B1265G02	\$2010.00
277 Volts	120/240 Volts	7.5	60 Hz	(-2 5.1%)	2	147	16600	9T21B1047G02	\$1342.00
277 Volts	120/240 Volts	10	60 Hz	(-2 5.1%)	2	198	19400	9T21B1048G02	\$1712.00
277 Volts	120/240 Volts	10	60 Hz	(-2 2.5%)	2	198	19400	9T21B1266G02	\$3013.66
277 Volts	120/240 Volts	15	60 Hz	(-2 5.1%)	2	220	19500	9T21B9143	\$2262.00
277 Volts	120/240 Volts	25	60 Hz	(-2 4.7%)	2	388	50500	9T21B9144	\$3018.00

¹See page 8-44 for wiring diagrams.

5 - 25 kVA Indoor/Outdoor Type QMS 115°C Rise UL Listed C-UL Listed

Input Voltage	Output Voltage	kVA	Frequency (Hz)	Taps	Wiring Diagram No. ¹	Weight (Lbs)	Frame Size	Product Number	List Price GO-90C
240 x 480 Volts	120/240 Volts	5	60	No Taps	1	103	16350	9T21B1004G02	\$802.00
240 x 480 Volts	120/240 Volts	5	50	No Taps	1	115	16400	9T21B1055G02	\$890.00
240 x 480 Volts	120/240 Volts	7.5	60	No Taps	1	147	16600	9T21B1005G02	\$1113.00
240 x 480 Volts	120/240 Volts	7.5	50	No Taps	1	174	16600	9T21B1056G02	\$1241.00
240 x 480 Volts	120/240 Volts	10	60	No Taps	1	198	19400	9T21B1006G02	\$1426.00
240 x 480 Volts	120/240 Volts	10	50	No Taps	1	198	19400	9T21B1057G02	\$1575.00
240 x 480 Volts	120/240 Volts	15	60	No Taps	1	220	19500	9T21B9103	\$1943.00
240 x 480 Volts	120/240 Volts	15	50	No Taps	1	233	19550	9T21B9133	\$2159.00
240 x 480 Volts	120/240 Volts	25	60	No Taps	1	388	50500	9T21B9104	\$2894.00
240 x 480 Volts	120/240 Volts	25	50	No Taps	1	428	50600	9T21B9134	\$3186.00
480 Volts	120/240 Volts	5	60	(-2 5.0%)	2	103	16350	9T21B1007G02	\$821.00
480 Volts	120/240 Volts	5	60	(+2,-2 2.5%)	3	103	16350	9T21B1013G02	\$909.00
480 Volts	120/240 Volts	7.5	60	(-2 5.0%)	2	147	16600	9T21B1008G02	\$1128.00
480 Volts	120/240 Volts	7.5	60	(+2,-2 2.5%)	3	147	16600	9T21B1014G02	\$1247.00
480 Volts	120/240 Volts	10	60	(-2 4.9%)	2	198	19400	9T21B1009G02	\$1451.00
480 Volts	120/240 Volts	10	60	(+2,-2 2.6%)	3	198	19400	9T21B1015G02	\$1583.00
480 Volts	120/240 Volts	15	60	(-2 5.0%)	2	220	19500	9T21B9105	\$1966.00
480 Volts	120/240 Volts	15	60	(+2,-2 2.5%)	3	220	19500	9T21B9109	\$2159.00
480 Volts	120/240 Volts	25	60	(-2 5.0%)	2	388	50500	9T21B9106	\$2917.00
480 Volts	120/240 Volts	25	60	(+2,-2 2.5%)	3	388	50500	9T21B9110	\$3186.00
600 Volts	120/240 Volts	5	60	No Taps	5	103	16350	9T21B1016G02	\$859.00
600 Volts	120/240 Volts	5	60	(-2 5.0%)	2	103	16350	9T21B1019G02	\$890.00
600 Volts	120/240 Volts	5	60	(+2,-2 2.5%)	107	16350	9T21B1025G02	\$1500.10	
600 Volts	120/240 Volts	7.5	60	(-2 5.0%)	2	147	16600	9T21B1020G02	\$1224.00
600 Volts	120/240 Volts	10	60	(-2 4.9%)	2	198	19400	9T21B1021G02	\$1420.00
600 Volts	120/240 Volts	15	60	No Taps	5	220	19500	9T21B9111	\$2060.00
600 Volts	120/240 Volts	15	60	(-2 4.8%)	2	220	19500	9T21B9113	\$2134.00
600 Volts	120/240 Volts	25	60	(-2 5.0%)	2	388	50500	9T21B9114	\$3196.00

¹See page 8-44 for wiring diagrams..



Transformers Buck-Boost Encapsulated

Autotransformers
For Bucking and Boosting Voltage

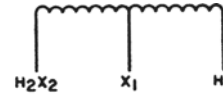

Wiring Diagram: Single-Phase

Application

For General Lighting and Power Service

Autotransformers are more economical than isolation transformers designed to carry the same load. Within their voltage limitations, they will perform the same function as transformers with the exception of insulating two circuits. You can use these autotransformers to obtain 120 Volts from a 240 Volt circuit, to derive a neutral on a 240 Volt, two-wire circuit, or to balance a 120/240 Volt, three-wire circuit. They also may be used in banks on polyphase circuits. See footnotes below.



Wiring Diagram: Three-Phase

For Bucking or Boosting Voltage of Single-Phase Indoor/Outdoor Type QB 60 Hz UL Listed CSA Certified¹

Input Voltage	Output Voltage	kVA ²	Height (in)	Width (in)	Depth (in)	Approx. Net Weight (Lbs.)	Frame Size	Product Number	List Price GO-90A
240/120 Volts	120 or 240/120 Volts (Three-Wire)	0.5	7.38	6.13	4.25	10	8175	9T51B0136	\$129.00
240/120 Volts	120 or 240/120 Volts (Three-Wire)	0.75	8.38	6.88	4.88	16	10200	9T51B0137	\$155.00
240/120 Volts	120 or 240/120 Volts (Three-Wire)	1	8.38	6.88	4.88	16	10200	9T51B0138	\$174.00
240/120 Volts	120 or 240/120 Volts (Three-Wire)	1.5	9.63	7.88	5.5	25	12200	9T51B0139	\$223.00
240/120 Volts	120 or 240/120 Volts (Three-Wire)	2	9.63	7.88	5.5	25	12225	9T51B0140	\$279.00
240/120 Volts	120 or 240/120 Volts (Three-Wire)	3	11.13	9.38	6.75	40	14200	9T51B0141	\$311.00
240/120 Volts	120 or 240/120 Volts (Three-Wire)	5	11.13	9.38	6.75	60	14400	9T51B0142	\$498.00

¹Through 3 kVA

For Bucking or Boosting Voltage of Single-Phase Indoor/Outdoor Type QMS 60 Hz UL Listed CSA Certified

Input Voltage	Output Voltage	kVA ²	Height (in)	Width (in)	Depth (in)	Approx. Net Weight (Lbs.)	Frame Size	Product Number	List Price GO-90C
240/120 Volts	120 or 240/120 Volts (Three-Wire)	10	14.50	10.62	11.00	103	16350	9T21B4553G02	\$853.00
240/120 Volts	120 or 240/120 Volts (Three-Wire)	15	17.06	10.62	11.00	147	16600	9T21B9201	\$1063.00
240/120 Volts	120 or 240/120 Volts (Three-Wire)	25	17.06	12.50	12.50	220	19500	9T21B9202	\$1487.00

²kVA output at 120 Volts, two-wire, or allowable unbalance at 240/120 Volts, three-wire.

For Boosting Voltage of Three-Phase Indoor/Outdoor Type QB 60 Hz UL Listed

Input Voltage	Output Voltage	kVA ³	Height (in)	Width (in)	Depth (in)	Approx. Net Weight (Lbs.)	Frame Size	Product Number	List Price GO-90A
208Y/120 Volts	230/133 Volts	6	7.38	6.13	4.25	10	8175	9T51B0143	\$122.00
208Y/120 Volts	230/133 Volts	9	8.38	6.88	4.88	16	10200	9T51B0144	\$147.00
208Y/120 Volts	230/133 Volts	15	8.38	6.88	4.88	20	10225	9T51B0145	\$188.00
208Y/120 Volts	230/133 Volts	30	9.63	7.88	5.50	30	12275	9T51B0146	\$302.00
208Y/120 Volts	230/133 Volts	45	11.13	9.38	6.75	40	14200	9T51B0147	\$403.75
208Y/120 Volts	230/133 Volts	75	11.13	9.38	6.75	60	14400	9T51B0148	\$540.00
208Y/120 Volts	240/120 Volts	6	7.38	6.13	4.25	10	8175	9T51B0150	\$147.00
208Y/120 Volts	240/120 Volts	15	9.63	7.88	5.50	25	12200	9T51B0152	\$237.00
208Y/120 Volts	240/120 Volts	30	11.13	9.38	6.75	40	14200	9T51B0153	\$361.00
208Y/120 Volts	240/120 Volts	45	11.13	9.38	6.75	45	14250	9T51B0154	\$445.00

³Bank of three single-phase autotransformers to be connected wye. Price is for one single unit. Dimensions and weights are for each unit in bank. Each single autotransformer is rated 1/3 of the bank kVA rating. Order three single-phase transformers for each three-phase bank.

Conversion Chart

Decimal	Fraction
.13	1/8
.38	3/8
.63	5/8
.88	7/8



Publications and Reference: See Section 22 for a complete list of additional product-related publications

Product Description

Buck boost transformers are small, single-phase, dry type distribution transformers designed and shipped as insulating/isolating transformers. They have a dual voltage primary and a dual voltage secondary. These transformers can be connected for a wide range of voltage combinations. The most common use is to buck (lower) or boost (raise) the supply voltage a small amount, usually 5 to 27%. Buck boost transformers comply with NEC Article 210-9, Exception 1, when field connected as an autotransformer.

GE bucking and boosting transformers provide an economical and convenient means for bucking or boosting voltage, usually no more than $\pm 20\%$ on single- and three-phase circuits. They are compact, relatively light in weight, and can be easily installed for indoor or outdoor service.

Buck-boost transformers are employed primarily for boosting single- and three-phase circuits by connecting them as autotransformers. When connected as an autotransformer, only the low-voltage, high-current capacity secondary windings are required to carry the load. Because this load is only transformed over a small change in voltage, the buck-boost transformer can handle loads many times its nameplate kVA rating.

The transformers with series-multiple 12/24, 24/48, or 16/32 Volt secondary windings are suitable for a wide variety of applications. Two or more units can be used in various combinations to obtain many other special voltages. (For fluctuating voltage conditions, refer to Power Conditioning Equipment Products section starting on page 8-34).

Advantages

- Efficient insulating materials permit compact size and light weight
- Dual voltage primary and dual voltage secondary for maximum versatility
- Large, front-accessible wiring compartment permits fast, easy wiring
- Convenient conduit knockouts located on side, bottom and back of wiring compartment
- GE Buck-Boost Transformer Selector makes selection fast and easy
- Many GE buck-boost transformers fit competitor mounting footprints
- Indoor or outdoor service

Key Features

- Convenient and least expensive method of matching line voltage with equipment voltage
- More efficient than equivalent isolation transformers
- Ability to handle loads up to 20 times nameplate rating when connected as an autotransformer
- Ideal for changing line voltages by small amounts
- Primary voltages include 120V, 240V and 480V
- Secondary voltages include 12V, 16V, 24V, 32V, 48V
- UL and cUL Listed
- Qualified to the seismic requirements of IEEE-693-1997 and IBC-2003



Indoor/Outdoor Type QB Transformer; Single-Phase

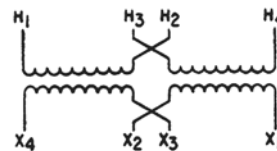

Wiring Diagram for Low Voltage Loads

Applications

- International voltage adaptation
- Commercial and industrial air conditioning
- Heating systems
- Induction motors
- Voltage line drop correction
- Landscape lighting
- Low-voltage lighting

Efficient operation of electrical equipment requires that line voltage be at or near the nameplate rating of the equipment. In order to match available line voltage (whether it be too high or low) with equipment voltage, buck-boost transformers provide the most convenient and least expensive method.

Do not use buck-boost transformers to solve a fluctuating voltage problem. They should be used to compensate for high- or low-voltage conditions only when the available line voltage is reasonably constant.



Transformers

Buck-Boost

Encapsulated

For Bucking and Boosting Voltage

Single-Phase Indoor/Outdoor Type QB 60 Hz UL Listed C-UL Listed

Input Voltage	Output Voltage	kVA	Height (in)	Width (in)	Depth (in)	Approx. Net Weight (Lbs.)	Frame Size	Product Number	List Price GO-90B
120/240 Volts	12/24 Volts	0.05	6.38	5.12	3.25	6	6100	9T51B0102	\$87.00
120/240 Volts	12/24 Volts	0.075	6.38	5.12	3.25	6	6200	9T51B0103	\$96.50
120/240 Volts	12/24 Volts	0.1	6.38	5.12	3.25	6	6200	9T51B0104	\$104.00
120/240 Volts	12/24 Volts	0.15	7.38	6.12	4.25	10	8175	9T51B0105	\$127.00
120/240 Volts	12/24 Volts	0.25	7.38	6.12	4.25	10	8175	9T51B0107	\$153.00
120/240 Volts	12/24 Volts	0.5	8.38	6.88	4.88	20	10225	9T51B0108	\$209.00
120/240 Volts	12/24 Volts	0.75	9.62	7.88	5.50	25	12200	9T51B0109	\$269.00
120/240 Volts	12/24 Volts	1	9.62	7.88	5.50	25	12225	9T51B0110	\$334.00
120/240 Volts	12/24 Volts	1.5	11.12	9.38	6.72	40	14200	9T51B0111	\$410.00
120/240 Volts	12/24 Volts	2	11.12	9.38	6.72	50	14300	9T51B0112	\$496.00
120/240 Volts	12/24 Volts	3	9.38	9.38	6.72	55	14350	9T51B0113	\$666.00
120/240 Volts	16/32 Volts	0.05	6.38	5.12	3.25	6	6100	9T51B0122	\$87.00
120/240 Volts	16/32 Volts	0.075	6.38	5.12	3.25	6	6200	9T51B0123	\$96.50
120/240 Volts	16/32 Volts	0.1	6.38	5.12	3.25	6	6200	9T51B0124	\$104.00
120/240 Volts	16/32 Volts	0.15	7.38	6.12	4.25	10	8175	9T51B0125	\$127.00
120/240 Volts	16/32 Volts	0.25	7.38	6.12	4.25	10	8175	9T51B0127	\$153.00
120/240 Volts	16/32 Volts	0.5	8.38	6.88	4.88	20	10225	9T51B0128	\$209.00
120/240 Volts	16/32 Volts	0.75	9.62	7.88	5.50	25	12200	9T51B0129	\$269.00
120/240 Volts	16/32 Volts	1	9.62	7.88	5.50	30	12300	9T51B0130	\$334.00
120/240 Volts	16/32 Volts	1.5	11.12	9.38	6.72	40	14200	9T51B0131	\$410.00
120/240 Volts	16/32 Volts	2	11.12	9.38	6.72	50	14300	9T51B0132	\$496.00
120/240 Volts	16/32 Volts	3	9.38	9.38	6.72	55	14350	9T51B0133	\$666.00
240/480 Volts	24/48 Volts	0.05	6.38	5.12	3.25	6	6100	9T51B0202	\$103.00
240/480 Volts	24/48 Volts	0.075	6.38	5.12	3.25	6	6200	9T51B0203	\$113.00
240/480 Volts	24/48 Volts	0.1	6.38	5.12	3.25	6	6200	9T51B0204	\$127.00
240/480 Volts	24/48 Volts	0.15	7.38	6.12	4.25	10	8175	9T51B0205	\$141.00
240/480 Volts	24/48 Volts	0.25	7.38	6.12	4.25	10	8175	9T51B0207	\$168.00
240/480 Volts	24/48 Volts	0.5	8.38	6.88	4.88	20	10225	9T51B0208	\$231.00
240/480 Volts	24/48 Volts	0.75	9.62	7.88	5.50	25	12200	9T51B0209	\$294.00
240/480 Volts	24/48 Volts	1	9.62	7.88	5.50	30	12275	9T51B0210	\$370.00
240/480 Volts	24/48 Volts	1.5	11.12	9.38	6.72	40	14200	9T51B0211	\$449.00
240/480 Volts	24/48 Volts	2	11.12	9.38	6.72	50	14300	9T51B0212	\$548.00
240/480 Volts	24/48 Volts	3	11.12	9.38	6.72	55	14350	9T51B0213	\$735.00

Single-Phase Indoor/Outdoor Type QMS 60 Hz UL Listed C-UL Listed

Input Voltage	Output Voltage	kVA	Height (in)	Width (in)	Depth (in)	Approx. Net Weight (Lbs.)	Frame Size	Product Number	List Price GO-90D
120/240 Volts	12/24 Volts	5	14.5	10.62	11	103	16350	9T21B1037G02	\$878.00
120/240 Volts	16/32 Volts	5	14.5	10.62	11	115	16400	9T21B1040G02	\$878.00

Single-Phase Indoor/Outdoor Type QMS 50 Hz UL Listed C-UL Listed

Input Voltage	Output Voltage	kVA	Height (in)	Width (in)	Depth (in)	Approx. Net Weight (Lbs.)	Frame Size	Product Number	List Price GO-90D
120/240 Volts	12/24 Volts	5	14.5	10.62	11	115	16400	9T21B1061G02	\$1538.30
120/240 Volts	16/32 Volts	5	14.5	10.62	11	127	16450	9T21B1064G02	\$1538.30

NOTE: In addition to bucking or boosting low circuit voltages to related value, these transformers can be used as two winding transformers to supply the rated nameplate low voltages, 12 to 48 Volts, two-wire or 12/24 to 24/48 Volts, three-wire. Also available in 50/60 Hz ratings.



Publications and Reference: See Section 22 for a complete list of additional product-related publications

Transformers

Buck-Boost Selection Tables

Encapsulated

For Bucking and Boosting Voltage

5-Step Selection

The tables on these pages greatly facilitate buck-boost transformer selection. Simply follow these five easy steps:

1. Refer to the table having the same "output voltage" as the equipment you want to operate. For example, if you are installing a 230 Volt single-phase air conditioner, use the 230 Volt table.
2. Different available "line voltages" are listed across the top of each table. Select the line voltage column closest to your actual supply. If your available line voltage is exactly midway between two listed voltage levels, you may use either voltage column. For example, in the 230 Volt table, if you have 212 available, use either the 208 or the 216 column.
3. Read down the available line voltage column until you reach the rated load kVA of the equipment you want to operate or "the next higher kVA" rating. For example, in the 230 Volt table under the 208 available line voltage column, you want to operate an air conditioner rated 2 kVA. Since 2 kVA is not listed as such, you must read down to the next higher value or 2.4 kVA.

4. Once you have established this point, read across to the far left column for the exact GE buck-boost model number for your application. For example, the 230 Volt table under the 208 column for a 2 kVA air conditioner, read across from 2.4 (next higher kVA rating) and the model number is 9T51B0107.
5. Connect the buck-boost transformer you have selected per the connection diagram specified at the "bottom" of the available line voltage column you used. For example, if you used the 208 column, you would connect the buck-boost transformer per connection diagram A. That's all there is to it! The transformer you've selected will meet your exact requirements when connected in the specified manner.

The formula for calculating single-phase kVA is:

$$\frac{\text{Load Voltage} \times \text{Full Load Amps}}{1000}$$

The formula for calculating three-phase kVA is:

$$\frac{1.732 \times \text{Load Voltage} \times \text{Load Amps}}{1000}$$

Table 1
230 Volts Output, 60 Hertz, Single-Phase

Product Number	Available Line Voltage									
	192	203	208	216	219	242	245	353	261	276
	Load kVA ¹									
9T51B0102	—	—	0.480	—	0.960	1.0	—	0.530	—	—
9T51B0122	—	0.360	—	0.720	—	—	0.770	—	0.410	—
9T51B0202	0.240	—	—	—	—	—	—	—	—	0.288
9T51B0103	—	—	0.720	—	1.5	1.6	—	0.800	—	—
9T51B0123	—	0.540	—	1.1	—	—	1.2	—	0.620	—
9T51B0203	0.359	—	—	—	—	—	—	—	—	0.431
9T51B0104	—	—	0.960	—	2.0	2.1	—	1.1	—	—
9T51B0124	—	0.720	—	1.5	—	—	1.6	—	0.820	—
9T51B0204	0.479	—	—	—	—	—	—	—	—	0.575
9T51B0105	—	—	1.5	—	2.9	3.1	—	1.6	—	—
9T51B0125	—	1.1	—	2.2	—	—	2.3	—	1.3	—
9T51B0205	0.719	—	—	—	—	—	—	—	—	0.863
9T51B0107	—	—	2.4	—	4.8	5.1	—	2.7	—	—
9T51B0127	—	1.8	—	3.6	—	—	3.9	—	2.1	—
9T51B0207	1.2	—	—	—	—	—	—	—	—	1.4
9T51B0108	—	—	4.8	—	9.6	10.1	—	5.3	—	—
9T51B0128	—	3.6	—	7.2	—	—	7.7	—	4.1	—
9T51B0208	2.4	—	—	—	—	—	—	—	—	2.9
9T51B0109	—	—	7.2	—	14.4	15.2	—	7.9	—	—
9T51B0129	—	5.4	—	10.8	—	—	11.5	—	6.2	—
9T51B0209	3.6	—	—	—	—	—	—	—	—	4.3
9T51B0110	—	—	9.6	—	19.2	20.2	—	10.6	—	—
9T51B0130	—	7.2	—	14.4	—	—	15.4	—	8.2	—
9T51B0210	4.8	—	—	—	—	—	—	—	—	5.7
9T51B0111	—	—	14.4	—	28.8	30.3	—	15.9	—	—
9T51B0131	—	10.8	—	21.6	—	—	23.0	—	12.3	—
9T51B0211	7.2	—	—	—	—	—	—	—	—	8.6
9T51B0112	—	—	19.1	—	38.4	40.4	—	21.1	—	—
9T51B0132	—	14.4	—	28.8	—	—	30.7	—	16.4	—
9T51B0212	9.6	—	—	—	—	—	—	—	—	11.5
9T51B0113	—	—	28.7	—	57.5	60.5	—	31.7	—	—
9T51B0133	—	21.6	—	43.2	—	—	46.0	—	24.5	—
9T51B0213	14.4	—	—	—	—	—	—	—	—	17.3
9T21B1037G02	—	—	47.8	—	95.9	100.9	—	52.7	—	—
9T21B1040G02	—	36.0	—	72.0	—	—	77.0	—	40.8	—
Connection Diagram	C	A	A	B	B	B	B	A	A	C
Page 8-63										

¹The load kVA is the maximum load at voltages shown when transformers are connected as autotransformers according to the diagram referenced.



Transformers

Buck-Boost Selection Tables

Encapsulated

For Bucking and Boosting Voltage

Table 2
240 Volts Output, 60 Hertz, Single-Phase

Product Number	Available Line Voltage									
	200	212	218	225	229	252	256	264	272	288
	Load kVA ¹									
9T51B0102	—	—	0.500	—	1.0	1.1	—	0.6	—	—
9T51B0122	—	0.380	—	0.750	—	—	0.800	—	0.430	—
9T51B0202	0.250	—	—	—	—	—	—	—	—	0.300
9T51B0103	—	—	0.750	—	1.5	1.6	—	0.825	—	—
9T51B0123	—	0.570	—	1.2	—	—	1.2	—	0.640	—
9T51B0203	0.375	—	—	—	—	—	—	—	—	0.391
9T51B0104	—	—	1.0	—	2.0	2.1	—	1.1	—	—
9T51B0124	—	0.750	—	1.5	—	—	1.6	—	0.850	—
9T51B0204	0.500	—	—	—	—	—	—	—	—	0.522
9T51B0105	—	—	1.5	—	3.0	3.2	—	1.7	—	—
9T51B0125	—	1.2	—	2.3	—	—	2.4	—	1.3	—
9T51B0205	0.750	—	—	—	—	—	—	—	—	0.782
9T51B0107	—	—	2.5	—	5.0	5.3	—	2.8	—	—
9T51B0127	—	1.9	—	3.8	—	—	4.0	—	2.2	—
9T51B0207	1.3	—	—	—	—	—	—	—	—	1.4
9T51B0108	—	—	5.0	—	10.0	10.5	—	5.5	—	—
9T51B0128	—	3.8	—	7.5	—	—	8.0	—	4.3	—
9T51B0208	2.5	—	—	—	—	—	—	—	—	2.6
9T51B0109	—	—	7.5	—	15.0	15.8	—	8.3	—	—
9T51B0129	—	5.7	—	11.3	—	—	12.0	—	6.4	—
9T51B0209	3.8	—	—	—	—	—	—	—	—	4.0
9T51B0110	—	—	10.0	—	20.0	21.0	—	11.0	—	—
9T51B0130	—	7.5	—	15.0	—	—	16.0	—	8.5	—
9T51B0210	5.0	—	—	—	—	—	—	—	—	5.2
9T51B0111	—	—	15.0	—	30.0	31.5	—	16.5	—	—
9T51B0131	—	11.3	—	22.5	—	—	24.0	—	12.8	—
9T51B0211	7.5	—	—	—	—	—	—	—	—	7.8
9T51B0112	—	—	20.0	—	40.0	42.6	—	22.0	—	—
9T51B0132	—	15.0	—	30.0	—	—	32.0	—	17.0	—
9T51B0212	10.0	—	—	—	—	—	—	—	—	10.4
9T51B0113	—	—	30.0	—	60.0	63.0	—	33.0	—	—
9T51B0133	—	22.5	—	45.0	—	—	48.0	—	25.5	—
9T51B0213	15.0	—	—	—	—	—	—	—	—	15.6
9T21B1037G02	—	—	50.0	—	100.0	105.0	—	55.0	—	—
9T21B1040G02	—	37.5	—	75.0	—	—	80.0	—	42.5	—
Connection Diagram	C	A	A	B	B	B	B	A	A	C
Page 8-63										

¹The load kVA is the maximum load at voltages shown when transformers are connected as autotransformers according to the diagram referenced.



Transformers

Buck-Boost Selection Tables

Encapsulated

For Bucking and Boosting Voltage

Section 8

Table 3
115 Volts Output, 60 Hertz, Single-Phase

Product Number	Available Line Voltage							
	91	96	101	105	127	130	138	146
	Load kVA ¹							
9T51B0102	—	0.240	—	0.480	0.539	—	0.290	—
9T51B0122	0.180	—	0.360	—	—	0.410	—	0.230
9T51B0103	—	0.360	—	0.720	0.800	—	0.440	—
9T51B0123	0.270	—	0.540	—	—	0.610	—	0.350
9T51B0104	—	0.480	—	0.960	1.1	—	0.580	—
9T51B0124	0.360	—	0.720	—	—	0.820	—	0.460
9T51B0105	—	0.720	—	1.5	1.6	—	0.870	—
9T51B0125	0.540	—	1.1	—	—	1.3	—	0.690
9T51B0107	—	1.2	—	2.4	2.7	—	1.5	—
9T51B0127	0.900	—	1.8	—	—	2.1	—	1.2
9T51B0108	—	2.4	—	4.8	5.3	—	2.9	—
9T51B0128	1.8	—	3.6	—	—	4.1	—	2.3
9T51B0109	—	3.6	—	7.2	8.0	—	4.4	—
9T51B0129	2.7	—	5.4	—	—	6.1	—	3.5
9T51B0110	—	4.8	—	9.6	10.6	—	5.8	—
9T51B0130	3.6	—	7.2	—	—	8.2	—	4.6
9T51B0111	—	7.2	—	14.4	15.9	—	8.6	—
9T51B0131	5.4	—	10.8	—	—	12.2	—	6.9
9T51B0112	—	9.6	—	19.2	21.2	—	11.5	—
9T51B0132	7.2	—	14.4	—	—	16.3	—	9.2
9T51B0113	—	14.4	—	28.8	31.8	—	17.3	—
9T51B0133	10.8	—	21.6	—	—	24.4	—	13.7
9T21B1061G02	—	24.0	—	48.0	53.0	—	28.8	—
9T21B1037G02	—	24.0	—	48.0	53.0	—	28.8	—
9T21B1064G02	18.0	—	36.0	—	—	41.0	—	22.9
9T21B1040G02	18.0	—	36.0	—	—	41.0	—	22.9
Connection Diagram	C	C	D	D	D	D	C	C

¹The load kVA is the maximum load at voltages shown when transformers are connected as autotransformers according to the diagram referenced.

Table 4
120 Volts Output, 60 Hertz, Single-Phase

Product Number	Available Line Voltage							
	95	100	106	109	132	136	144	152
	Load kVA ¹							
9T51B0102	—	0.250	—	0.500	0.550	—	0.300	—
9T51B0122	0.190	—	0.380	—	—	0.430	—	0.240
9T51B0103	—	0.380	—	0.750	0.830	—	0.450	—
9T51B0123	0.290	—	0.570	—	—	0.640	—	0.360
9T51B0104	—	0.500	—	1.0	1.1	—	0.600	—
9T51B0124	0.380	—	0.750	—	—	0.850	—	0.480
9T51B0105	—	0.750	—	1.5	1.7	—	0.900	—
9T51B0125	0.570	—	1.2	—	—	1.3	—	0.720
9T51B0107	—	1.3	—	2.5	2.8	—	1.5	—
9T51B0127	0.940	—	1.9	—	—	2.2	—	1.2
9T51B0108	—	2.5	—	5.0	5.5	—	3.0	—
9T51B0128	1.9	—	3.8	—	—	4.3	—	2.4
9T51B0109	—	3.8	—	7.5	8.3	—	4.5	—
9T51B0129	2.9	—	5.7	—	—	6.4	—	3.6
9T51B0110	—	5.0	—	10.0	11.0	—	6.0	—
9T51B0130	3.8	—	7.5	—	—	8.5	—	4.8
9T51B0111	—	7.5	—	15.0	16.5	—	9.0	—
9T51B0131	5.7	—	11.3	—	—	12.8	—	7.2
9T51B0112	—	10.0	—	20.0	22.0	—	12.0	—
9T51B0132	7.5	—	15.0	—	—	17.0	—	9.5
9T51B0113	—	15.0	—	30.0	33.0	—	18.0	—
9T51B0133	11.3	—	22.5	—	—	25.5	—	14.3
9T21B1061G02	—	25.0	—	50.0	55.0	—	30.0	—
9T21B1037G02	—	25.0	—	50.0	55.0	—	30.0	—
9T21B1064G02	18.8	—	38.0	—	—	43.0	—	23.8
9T21B1040G02	18.8	—	38.0	—	—	43.0	—	23.8
Connection Diagram	C	C	D	D	D	D	C	C

¹The load kVA is the maximum load at voltages shown when transformers are connected as autotransformers according to the diagram referenced.



Transformers

Buck-Boost Selection Tables

Encapsulated

For Bucking and Boosting Voltage

Table 5
230 Volts, 3-Wire Output, 60 Hertz, Three-Phase²

Quantity Required Per Bank	Product Number	Available Line Voltage				
		181V/105	192V/111	203V/117	208V/120	277V/160
		Load kVA ¹				
3	9T51B0102	—	0.830	—	1.7	—
3	9T51B0122	0.620	—	1.3	—	—
3	9T51B0202	—	—	—	—	0.480
3	9T51B0103	—	1.2	—	2.5	—
3	9T51B0123	0.930	—	1.9	—	—
3	9T51B0203	—	—	—	—	0.720
3	9T51B0104	—	1.7	—	3.4	—
3	9T51B0124	1.2	—	2.5	—	—
3	9T51B0204	—	—	—	—	0.960
3	9T51B0105	—	2.5	—	5.0	—
3	9T51B0125	1.9	—	3.7	—	—
3	9T51B0205	—	—	—	—	1.44
3	9T51B0107	—	4.2	—	8.3	—
3	9T51B0127	3.1	—	6.2	—	—
3	9T51B0207	—	—	—	—	2.4
3	9T51B0108	—	8.3	—	16.6	—
3	9T51B0128	6.2	—	12.5	—	—
3	9T51B0208	—	—	—	—	4.8
3	9T51B0109	—	12.5	—	25.0	—
3	9T51B0129	9.3	—	18.7	—	—
3	9T51B0209	—	—	—	—	7.2
3	9T51B0110	—	16.6	—	33.2	—
3	9T51B0130	12.5	—	25.0	—	—
3	9T51B0210	—	—	—	—	9.6
3	9T51B0111	—	25.0	—	50.0	—
3	9T51B0131	18.7	—	37.0	—	—
3	9T51B0211	—	—	—	—	14.4
3	9T51B0112	—	33.0	—	66.0	—
3	9T51B0132	25.0	—	50.0	—	—
3	9T51B0212	—	—	—	—	19.2
3	9T51B0113	—	50.0	—	100.0	—
3	9T51B0133	37.5	—	75.0	—	—
3	9T51B0213	—	—	—	—	28.8
3	9T21B1037G02	—	83.0	—	167.0	—
3	9T21B1040G02	62.0	—	125.0	—	—
	Connection Diagram Page 8-63	F	F	G	G	F

¹The load kVA is the maximum load at voltages shown when transformers are connected as autotransformers according to the diagram referenced.

²See Caution page 8-61, footnote 1.



Transformers

Buck-Boost Selection Tables

Encapsulated

For Bucking and Boosting Voltage

Section 8

Table 6
240 Volts, 3-Wire Output, 60 Hertz, Three-Phase²

Quantity Required Per Bank	Product Number	Available Line Voltage				
		189V/109	200V/115	208V/120 ³ 212V/122	218V/126	288V/166
		Load kVA ¹				
3	9T51B0102	—	0.870	—	1.7	—
3	9T51B0122	0.650	—	1.3	—	—
3	9T51B0202	—	—	—	—	0.500
3	9T51B0103	—	1.3	—	2.6	—
3	9T51B0123	0.970	—	2.0	—	—
3	9T51B0203	—	—	—	—	0.750
3	9T51B0104	—	1.7	—	3.5	—
3	9T51B0124	1.3	—	2.6	—	—
3	9T51B0204	—	—	—	—	1.0
3	9T51B0105	—	2.6	—	5.2	—
3	9T51B0125	2.0	—	3.9	—	—
3	9T51B0205	—	—	—	—	1.5
3	9T51B0107	—	4.3	—	8.7	—
3	9T51B0127	3.2	—	6.5	—	—
3	9T51B0207	—	—	—	—	2.5
3	9T51B0108	—	8.7	—	17.3	—
3	9T51B0128	6.5	—	13.0	—	—
3	9T51B0208	—	—	—	—	5.0
3	9T51B0109	—	13.0	—	26.0	—
3	9T51B0129	9.7	—	19.5	—	—
3	9T51B0209	—	—	—	—	7.5
3	9T51B0110	—	17.3	—	34.6	—
3	9T51B0130	13.0	—	26.0	—	—
3	9T51B0210	—	—	—	—	10.0
3	9T51B0111	—	26.0	—	52.0	—
3	9T51B0131	19.5	—	39.0	—	—
3	9T51B0211	—	—	—	—	15.0
3	9T51B0112	—	35.0	—	70.0	—
3	9T51B0132	26.0	—	52.0	—	—
3	9T51B0212	—	—	—	—	20.0
3	9T51B0113	—	52.0	—	104.0	—
3	9T51B0133	39.0	—	78.0	—	—
3	9T51B0213	—	—	—	—	30.0
3	9T21B1037G02	—	87.0	—	173.0	—
3	9T21B1040G02	65.0	—	130.0	—	—
Connection Diagram Page 8-63		F	F	G	G	F

¹The load kVA is the maximum load at voltages shown when transformers are connected as autotransformers according to the diagram referenced.

²See Caution page 8-61, footnote 1.

³When 208V/120 Volts is the available line voltage, the 212V/122 column may be used to obtain 236 Volts which should be satisfactory for most applications.



Transformers

Buck-Boost Selection Tables

Encapsulated

For Bucking and Boosting Voltage

Table 7

460 Volts, 3-Wire Output, 60 Hertz, Three-Phase¹

Quantity Required Per Bank	Product Number	Available Line Voltage — 3- or 4-Wire				
		385	406	418	432	438
		Load kVA ²				
3	9T51B0102	—	—	1.66	—	3.32
3	9T51B0122	—	1.25	—	2.49	—
3	9T51B0202	0.830	—	—	—	—
3	9T51B0103	—	—	2.48	—	4.96
3	9T51B0123	—	1.87	—	3.73	—
3	9T51B0203	1.2	—	—	—	—
3	9T51B0104	—	—	3.31	—	6.62
3	9T51B0124	—	2.49	—	4.97	—
3	9T51B0204	1.7	—	—	—	—
3	9T51B0105	—	—	4.97	—	9.94
3	9T51B0125	—	3.73	—	3.9	—
3	9T51B0205	2.5	—	—	—	—
3	9T51B0107	—	—	8.28	—	16.6
3	9T51B0127	—	6.22	—	6.5	—
3	9T51B0207	4.2	—	—	—	—
3	9T51B0108	—	—	16.6	—	33.2
3	9T51B0128	—	12.5	—	13.0	—
3	9T51B0208	8.3	—	—	—	—
3	9T51B0109	—	—	24.8	—	59.6
3	9T51B0129	—	18.7	—	19.5	—
3	9T51B0209	12.5	—	—	—	—
3	9T51B0110	—	—	33.1	—	66.2
3	9T51B0130	—	24.9	—	26.0	—
3	9T51B0210	16.6	—	—	—	—
3	9T51B0111	—	—	49.7	—	99.4
3	9T51B0131	—	37.3	—	39.0	—
3	9T51B0211	24.9	—	—	—	—
3	9T51B0112	—	—	66.3	—	133.0
3	9T51B0132	—	49.7	—	52.0	—
3	9T51B0212	33.2	—	—	—	—
3	9T51B0113	—	—	99.3	—	198.6
3	9T51B0133	—	74.6	—	78.0	—
3	9T51B0213	49.8	—	—	—	—
3	9T21B1037G02	—	—	166.0	—	322.0
3	9T21B1040G02	—	125.0	—	130.0	—
Connection Diagram Page 8-63		F	H	H	I	I

¹**Caution:** If input is 3-wire Delta or 4-wire midtapped Delta, the neutral established from the bank of buck-boost transformers must be insulated and isolated from the input power neutral and/or ground.

²The load kVA is the maximum load at voltages shown when transformers are connected as autotransformers according to the diagram referenced.



Transformers

Buck-Boost Selection Tables

Encapsulated

For Bucking and Boosting Voltage

Section 8

Table 8

480 Volts, 3-Wire Output, 60 Hertz, Three-Phase¹

Quantity Required Per Bank	Product Number	Available Line Voltage — 3- or 4-Wire			
		400	424	436	450
		Load kVA ²			
	9T51B0102	—	—	1.74	—
3	9T51B0122	—	1.3	—	2.6
3	9T51B0202	0.866	—	—	—
3	9T51B0103	—	—	2.6	—
3	9T51B0123	—	1.95	—	3.9
3	9T51B0203	1.3	—	—	—
3	9T51B0104	—	—	3.5	—
3	9T51B0124	—	2.6	—	5.2
3	9T51B0204	1.7	—	—	—
3	9T51B0105	—	—	5.2	—
3	9T51B0125	—	3.9	—	7.8
3	9T51B0205	2.6	—	—	—
3	9T51B0107	—	—	8.7	—
3	9T51B0127	—	6.3	—	13.0
3	9T51B0207	4.3	—	—	—
3	9T51B0108	—	—	17.4	—
3	9T51B0128	—	13.0	—	26.0
3	9T51B0208	8.7	—	—	—
3	9T51B0109	—	—	26.0	—
3	9T51B0129	—	19.5	—	39.0
3	9T51B0209	13.0	—	—	—
3	9T51B0110	—	—	35.0	—
3	9T51B0130	—	26.0	—	52.0
3	9T51B0210	17.3	—	—	—
3	9T51B0111	—	—	52.2	—
3	9T51B0131	—	39.0	—	78.0
3	9T51B0211	26.0	—	—	—
3	9T51B0112	—	—	69.0	—
3	9T51B0132	—	52.0	—	104.0
3	9T51B0212	34.6	—	—	—
3	9T51B0113	—	—	104.0	—
3	9T51B0133	—	78.0	—	156.0
3	9T51B0213	51.9	—	—	—
3	9T21B1037G02	—	—	174.0	—
3	9T21B1040G02	—	130.0	—	260.0
	Connection Diagram Page 8-63	F	H	H	I

Table 9

208 Volts, 3-Wire, 60 Hertz, Three-Phase¹

Quantity Required Per Bank	Product Number	Available Line Voltage — 3- or 4-Wire			
		218	222	229	236
		Load kVA ²			
2	9T51B0102	1.6	—	0.800	—
2	9T51B0122	—	1.2	—	0.640
2	9T51B0103	2.3	—	1.2	—
2	9T51B0123	—	1.8	—	0.960
2	9T51B0104	3.2	—	1.6	—
2	9T51B0124	—	2.4	—	1.3
2	9T51B0105	4.7	—	2.5	—
2	9T51B0125	—	3.6	—	1.9
2	9T51B0107	7.8	—	4.1	—
2	9T51B0127	—	6.0	—	3.2
2	9T51B0108	16	—	8.0	—
2	9T51B0128	—	12.0	—	6.4
2	9T51B0109	23.6	—	12.4	—
2	9T51B0129	—	18.0	—	9.6
2	9T51B0110	31.5	—	16.5	—
2	9T51B0130	—	24.0	—	12.7
2	9T51B0111	47.5	—	24.8	—
2	9T51B0131	—	36.0	—	19.1
2	9T51B0112	63.0	—	33.0	—
2	9T51B0132	—	48.0	—	25.6
2	9T51B0113	94	—	49.6	—
2	9T51B0133	—	72.0	—	38.3
	Connection Diagram Page 8-63	J	J	Z	Z

¹Caution: If input is 3-wire Delta or 4-wire midtapped Delta, the neutral established from the bank of buck-boost transformers must be insulated and isolated from the input power neutral and/or ground.

²The load kVA is the maximum load at voltages shown when transformers are connected as autotransformers according to the diagram referenced.



Transformers

Buck-Boost Connection Diagrams

Encapsulated

For Bucking and Boosting Voltage

Connection Diagrams

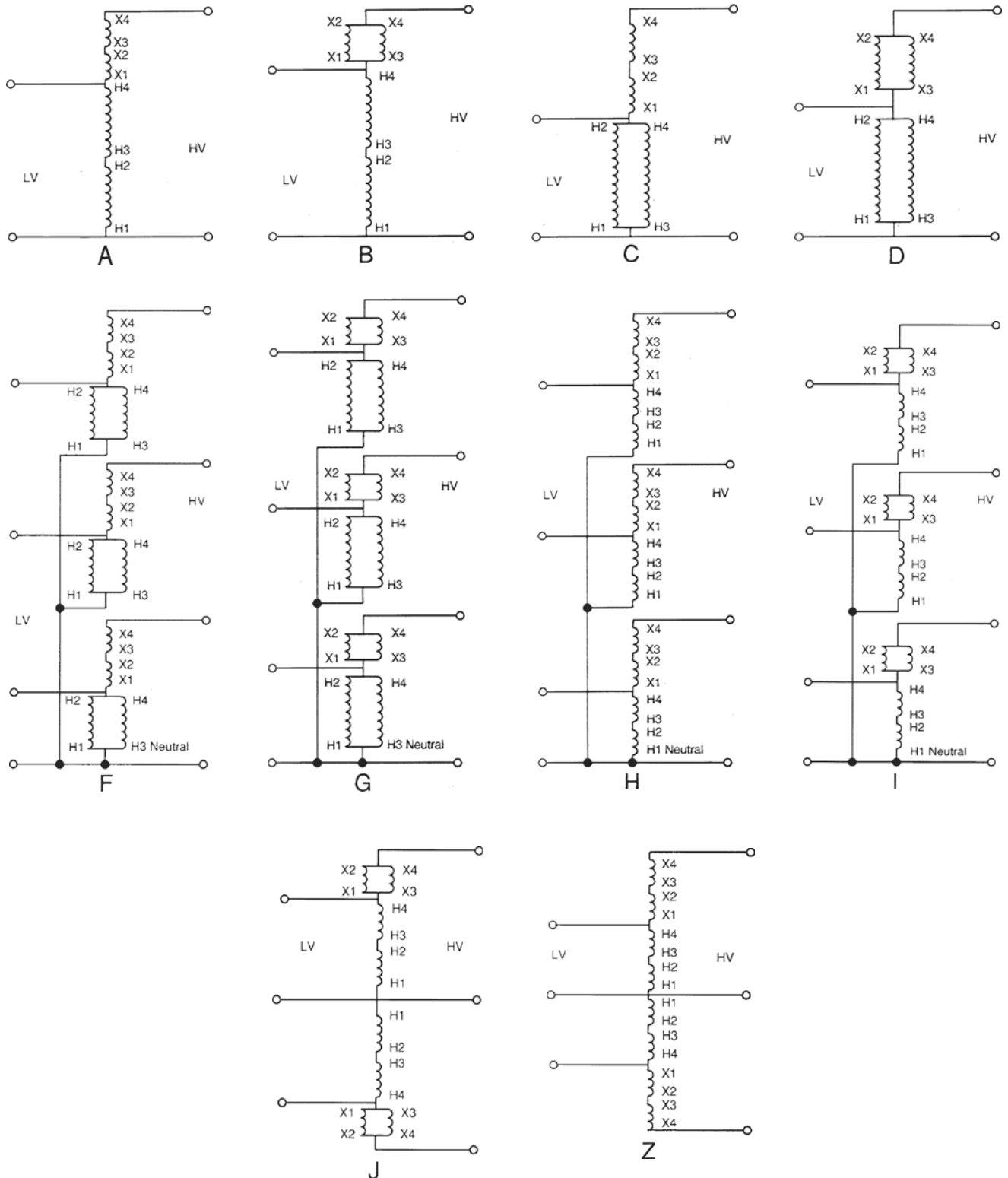

Publications and Reference: See Section 22 for a complete list of additional product-related publications

Transformers

Open Core and Coil Transformers

Machine Tool and Control Power

0.05-3.0kVA, Single-Phase

Description

Core and coil transformers for machine tools are used to provide voltage to control devices in applications where regulation and minimum space are important. They are encapsulated with welded cores to provide the highest quality electrical performance and quiet operation.

Standards: Type IP transformers conform to NEMA ST20

Listings: UL listed under UL-506, File E2739
CSA Certified under C22.2, Number 66, File 3272

Insulation Classes: 150VA and below: 105°C insulation class, 55°C Rise

200VA and above: 185°C (NEMA)
180°C (UL) insulation class, 115°C Rise

Frequency: 60 Hz standard; 50 Hz optional.

Voltage Regulation: All designs 2.0 kVA and below are compensated for voltage drop. Compensation ranges from 10% in the smallest rating to 3% for the largest. All machine tool designs meet or exceed NMTBA regulation requirements.

Series-Multiple Secondary Connections: Transformers with 120/240 V secondaries (series-multiple) may be connected for 120 V, 240 V or 240/120 V three-wire. Jumpers are provided.

Overcurrent Protection: Type IP transformers are low impedance transformers that require overcurrent protection for most applications. They provide for optional integral primary and/or secondary fusing.

Mounting Dimensions: Type IP transformers are lightweight, small, and designed for minimum mounting dimensions. Many units will fit competitors mounting footprints.



Core and Coil Transformer, Optional Leads Out Connection

Section 8



Core and Coil Transformer, Terminal Board Connection

Advantages—Terminal Board Connection

- Fully encapsulated coil is impervious to moisture
- Finger-safe terminals offer added protection and safety
- Pressure plate terminals ensure secure connections
- Terminal board is anchored in the epoxy for greater reliability
- Wide variety of fusing options

Key Features—Terminal Board Connection

- Rugged, high-impact plastic terminal board
- Full head #8 brass screws assure quick, easy terminations with maximum connection integrity
- Copper windings
- Flexible design allows input or output voltage to match any application
- CUL, CE, UL approvals
- Available fuse-clips offer simple, low-cost fusing with terminal block models



Transformers

Open Core and Coil Transformers

Machine Tool Applications

Single-Phase

60 Hz Terminal Board Connection

Input Voltage	Output Voltage	kVA	Inrush VA @ .20 PF, 95% Sec. Volt	Wiring Diagram No. ¹	Approx. Net Weight (Lbs)	Frame Size	Product Number	List Price GO-90
220x440, 230x460,240x480 Volts	110, 115, 120 Volts	0.05	193	1	3	6100	9T58K0042	\$25.00
220x440, 230x460,240x480 Volts	110, 115, 120 Volts	0.075	303	1	3	6125	9T58K0043	\$29.00
220x440, 230x460,240x480 Volts	110, 115, 120 Volts	0.1	396	1	4	8100	9T58K0044	\$33.00
220x440, 230x460,240x480 Volts	110, 115, 120 Volts	0.15	724	1	5	8150	9T58K0045	\$37.00
220x440, 230x460,240x480 Volts	110, 115, 120 Volts	0.2	821	1	6	8175	9T58K0046	\$46.00
220x440, 230x460,240x480 Volts	110, 115, 120 Volts	0.25	1034	1	7	8200	9T58K0047	\$54.00
220x440, 230x460,240x480 Volts	110, 115, 120 Volts	0.3	1037	1	8	8250	9T58K0048	\$60.00
220x440, 230x460,240x480 Volts	110, 115, 120 Volts	0.375	1441	1	8	8250	9T58K0049	\$69.50
220x440, 230x460,240x480 Volts	110, 115, 120 Volts	0.5	2027	1	12	10225	9T58K0050	\$79.00
220x440, 230x460,240x480 Volts	110, 115, 120 Volts	0.75	3092	1	16	12225	9T58K0051	\$110.00
220x440, 230x460,240x480 Volts	110, 115, 120 Volts	1	4494	1	19	12300	9T58K0052	\$135.00
220x440, 230x460,240x480 Volts	110, 115, 120 Volts	1.5	5156	1	28	14225	9T58K0053	\$185.00
220x440, 230x460,240x480 Volts	110, 115, 120 Volts	2	9193	1	34	14300	9T58K0054	\$249.00
220x440, 230x460,240x480 Volts	110, 115, 120 Volts	3	14513	1	45	14475	9T58K0055	\$331.00

50/60 Hz Terminal Board Connection

Input Voltage	Output Voltage	kVA	Inrush VA @ .20 PF, 95% Sec. Volt	Wiring Diagram No. ¹	Approx. Net Weight (Lbs)	Frame Size	Product Number	List Price GO-80
230/460/575 Volts	115/95 Volts	0.05	196	2	4	6150	9T58K0062	\$36.00
230/460/575 Volts	115/95 Volts	0.075	278	2	4	8100	9T58K0063	\$42.00
230/460/575 Volts	115/95 Volts	0.1	445	2	5	8150	9T58K0064	\$45.00
230/460/575 Volts	115/95 Volts	0.15	663	2	7	8200	9T58K0065	\$57.50
230/460/575 Volts	115/95 Volts	0.2	864	2	7	8200	9T58K0066	\$65.00
230/460/575 Volts	115/95 Volts	0.25	1137	2	8	8250	9T58K0067	\$77.00
230/460/575 Volts	115/95 Volts	0.3	1412	2	12	10225	9T58K0068	\$87.00
230/460/575 Volts	115/95 Volts	0.375	1670	2	12	10225	9T58K0069	\$96.00
230/460/575 Volts	115/95 Volts	0.5	1822	2	12	10225	9T58K0070	\$104.00
230/460/575 Volts	115/95 Volts	0.75	3524	2	19	12300	9T58K0071	\$140.00
230/460/575 Volts	115/95 Volts	1	4392	2	28	14225	9T58K0072	\$194.00
230/460/575 Volts	115/95 Volts	1.5	6753	2	34	14300	9T58K0073	\$251.00
230/460/575 Volts	115/95 Volts	2	11563	2	45	14475	9T58K0074	\$306.00
208/277/380 Volts	115/95 Volts	0.05	217	3	4	6150	9T58K0082	\$36.00
208/277/380 Volts	115/95 Volts	0.075	322	3	4	8100	9T58K0083	\$42.00
208/277/380 Volts	115/95 Volts	0.1	464	3	5	8150	9T58K0084	\$45.00
208/277/380 Volts	115/95 Volts	0.15	761	3	7	8200	9T58K0085	\$57.50
208/277/380 Volts	115/95 Volts	0.2	837	3	7	8200	9T58K0086	\$65.00
208/277/380 Volts	115/95 Volts	0.25	1198	3	8	8250	9T58K0087	\$77.00
208/277/380 Volts	115/95 Volts	0.3	1409	3	12	10225	9T58K0088	\$87.00
208/277/380 Volts	115/95 Volts	0.375	1674	3	12	10225	9T58K0089	\$96.00
208/277/380 Volts	115/95 Volts	0.5	1821	3	12	10225	9T58K0090	\$104.00
208/277/380 Volts	115/95 Volts	0.75	3771	3	19	12300	9T58K0091	\$140.00
208/277/380 Volts	115/95 Volts	1	4234	3	28	14225	9T58K0092	\$194.00
208/277/380 Volts	115/95 Volts	1.5	7091	3	34	14300	9T58K0093	\$251.00
208/277/380 Volts	115/95 Volts	2	11729	3	45	14475	9T58K0094	\$306.00

¹See page 8-69 for wiring diagrams.

Factory- or Field-Installed Options

Secondary Fusing—Factory- or field-installed secondary fuse clips are available. They are restricted to units with terminal strips and a single secondary voltage or secondary with one tap.

Dual Primary and Secondary Fusing—Factory- or field-installed dual primary and secondary fusing is available on all units, including leads out and multiple secondary voltages.

Leads Out—Terminal strip is replaced by rugged primary and secondary leads emanating from the top of the encapsulated coil.



Publications and Reference: See Section 22 for a complete list of additional product-related publications

Transformers

Open Core and Coil Transformers

Control

Single-Phase

Section 8

60 Hz Terminal Board Connection

Input Voltage	Output Voltage	kVA	Wiring Diagram No. ¹	Approx. Net Weight (Lbs)	Frame Size	Product Number	List Price GO-80
240 x 480 Volts	120/240 Volts	0.05	4	3	6100	9T58K2802	\$36.00
240 x 480 Volts	120/240 Volts	0.075	4	3	6125	9T58K2803	\$42.00
240 x 480 Volts	120/240 Volts	0.1	4	4	8100	9T58K2804	\$45.00
240 x 480 Volts	120/240 Volts	0.15	4	5	8150	9T58K2805	\$57.50
240 x 480 Volts	120/240 Volts	0.2	4	6	8175	9T58K2806	\$65.00
240 x 480 Volts	120/240 Volts	0.25	4	7	8200	9T58K2807	\$73.00
240 x 480 Volts	120/240 Volts	0.3	4	7	8200	9T58K2808	\$76.00
240 x 480 Volts	120/240 Volts	0.375	4	8	8250	9T58K2809	\$96.00
240 x 480 Volts	120/240 Volts	0.5	4	12	10225	9T58K2810	\$104.00
240 x 480 Volts	120/240 Volts	0.75	4	16	12225	9T58K2811	\$128.00
240 x 480 Volts	120/240 Volts	1	4	19	12300	9T58K2812	\$164.00
240 x 480 Volts	120/240 Volts	1.5	4	28	14225	9T58K2813	\$215.00
240 x 480 Volts	120/240 Volts	2	4	34	14300	9T58K2814	\$274.00
240 x 480 Volts	120/240 Volts	3	4	45	14475	9T58K2815	\$360.00
600 Volts	120/240 Volts	0.1	5	4	8100	9T58K2824	\$45.00
600 Volts	120/240 Volts	0.2	5	6	8175	9T58K2826	\$65.00
600 Volts	120/240 Volts	0.3	5	7	8200	9T58K2828	\$73.00
600 Volts	120/240 Volts	0.5	5	12	10225	9T58K2830	\$104.00
600 Volts	120/240 Volts	1	5	19	12300	9T58K2832	\$194.00
600 Volts	120/240 Volts	2	5	34	14300	9T58K2834	\$306.00
600 Volts	120/240 Volts	3	5	45	14475	9T58K2835	\$398.00
120 x 240 Volts	120/240 Volts	0.1	6	4	8100	9T58K2907	\$44.00
120 x 240 Volts	120/240 Volts	0.2	6	6	8175	9T58K2909	\$65.50
120 x 240 Volts	120/240 Volts	0.3	6	7	8200	9T58K2911	\$72.00
120 x 240 Volts	120/240 Volts	0.5	6	12	10225	9T58K2913	\$101.00
120 x 240 Volts	120/240 Volts	0.75	6	16	12225	9T58K2914	\$121.00
120 x 240 Volts	120/240 Volts	1	6	19	12300	9T58K2915	\$155.00
120 x 240 Volts	120/240 Volts	2	6	34	14300	9T58K2917	\$261.00
120 x 240 Volts	120/240 Volts	3	6	45	14475	9T58K2918	\$344.00

60 Hz Terminal Board Connection

Input Voltage	Output Voltage	kVA	Wiring Diagram No. ¹	Approx. Net Weight (Lbs)	Frame Size	Product Number	List Price GO-80
120 x 240 Volts	12/24 Volts	0.05	7	3	6100	9T58K2873	\$29.00
120 x 240 Volts	12/24 Volts	0.075	7	3	6125	9T58K2874	\$35.00
120 x 240 Volts	12/24 Volts	0.1	7	4	8100	9T58K2875	\$39.00
120 x 240 Volts	12/24 Volts	0.15	7	5	8150	9T58K2876	\$48.50
120 x 240 Volts	12/24 Volts	0.2	7	6	8175	9T58K2877	\$58.50
120 x 240 Volts	12/24 Volts	0.25	7	7	8200	9T58K2878	\$62.50
120 x 240 Volts	12/24 Volts	0.3	7	7	8200	9T58K2879	\$67.00
240 x 480 Volts	12/24 Volts	0.05	---	3	6100	9T58K3164	\$34.50
240 x 480 Volts	12/24 Volts	0.1	---	4	8100	9T58K4132	\$40.50
240 x 480 Volts	12/24 Volts	0.15	---	5	8150	9T58K4133	\$48.50
240 x 480 Volts	12/24 Volts	0.25	---	7	8200	9T58K3024	\$62.50
208 x 240 Volts	12/24 Volts	0.05	---	3	6100	9T58K4050	\$34.50
208 x 240 Volts	12/24 Volts	0.1	---	4	8100	9T58K4051	\$40.50
208 x 240 Volts	12/24 Volts	0.15	---	5	8150	9T58K4052	\$48.50
208 x 240 Volts	12/24 Volts	0.25	---	7	8200	9T58K4053	\$62.50

50/60 Hz Terminal Board Connection

Input Voltage	Output Voltage	kVA	Wiring Diagram No. ¹	Approx. Net Weight (Lbs)	Frame Size	Product Number	List Price GO-80
240 x 480 Volts	120/240 Volts	0.5	4	12	10225	9T58K2930	\$104.00
240 x 480 Volts	120/240 Volts	0.75	4	19	12300	9T58K2931	\$133.00
240 x 480 Volts	120/240 Volts	1	4	28	14225	9T58K2932	\$171.00
240 x 480 Volts	120/240 Volts	1.5	4	34	14300	9T58K2933	\$221.00
240 x 480 Volts	120/240 Volts	2	4	45	14475	9T58K2934	\$285.00
240 x 480 Volts	120/240 Volts	3	4	45	14475	9T58K2935	\$423.00
380/400/416 Volts	115/230 Volts	0.25	8	7	8200	9T58K2975	\$68.20
380/400/416 Volts	115/230 Volts	0.5	8	12	10225	9T58K2978	\$104.00
380/400/416 Volts	115/230 Volts	0.75	8	19	12300	9T58K2979	\$133.00
380/400/416 Volts	115/230 Volts	1	8	28	14225	9T58K2980	\$171.00
380/400/416 Volts	115/230 Volts	1.5	8	34	14300	9T58K2981	\$221.00
380/400/416 Volts	115/230 Volts	2	8	45	14475	9T58K2982	\$285.00
380/400/416 Volts	115/230 Volts	3	8	45	14475	9T58K2983	\$423.00

¹See page 8-69 for wiring diagrams.

²Secondary fusing not available.



Transformers

Open Core and Coil Transformers

Control

Single-Phase

60 Hz Leads Out Connection²

Input Voltage	Output Voltage	kVA	Wiring Diagram No. ¹	Approx. Net Weight (Lbs)	Frame Size	Product Number	List Price GO-80
120 x 240 Volts	12/24 Volts	0.05	7	3	6100	9T58K1873	\$29.00
120 x 240 Volts	12/24 Volts	0.075	7	3	6125	9T58K1874	\$35.00
120 x 240 Volts	12/24 Volts	0.1	7	4	8100	9T58K1875	\$39.00
120 x 240 Volts	12/24 Volts	0.15	7	5	8150	9T58K1876	\$48.50
120 x 240 Volts	12/24 Volts	0.2	7	6	8175	9T58K1877	\$58.50
120 x 240 Volts	12/24 Volts	0.25	7	7	8200	9T58K1878	\$62.50
120 x 240 Volts	12/24 Volts	0.3	7	7	8200	9T58K1879	\$67.00
120 x 240 Volts	12/24 Volts	0.5	7	12	10225	9T58K1881	\$93.00
120 x 240 Volts	12/24 Volts	0.75	7	16	12225	9T58K1882	\$118.00

60 Hz Leads Out Connection²

Input Voltage	Output Voltage	kVA	Wiring Diagram No. ¹	Approx. Net Weight (Lbs)	Frame Size	Product Number	List Price GO-80
240 x 480 Volts	120/240 Volts	0.05	4	3	6100	9T58K1802	\$36.00
240 x 480 Volts	120/240 Volts	0.075	4	3	6125	9T58K1803	\$42.00
240 x 480 Volts	120/240 Volts	0.1	4	4	8100	9T58K1804	\$45.00
240 x 480 Volts	120/240 Volts	0.15	4	5	8150	9T58K1805	\$57.50
240 x 480 Volts	120/240 Volts	0.2	4	6	8175	9T58K1806	\$65.00
240 x 480 Volts	120/240 Volts	0.25	4	7	8200	9T58K1807	\$73.00
240 x 480 Volts	120/240 Volts	0.3	4	7	8200	9T58K1808	\$76.00
240 x 480 Volts	120/240 Volts	0.375	4	8	8250	9T58K1809	\$96.00
240 x 480 Volts	120/240 Volts	0.5	4	12	10225	9T58K1810	\$104.00
240 x 480 Volts	120/240 Volts	0.75	4	16	12225	9T58K1811	\$128.00
240 x 480 Volts	120/240 Volts	1	4	19	12300	9T58K1812	\$164.00
240 x 480 Volts	120/240 Volts	1.5	4	28	14225	9T58K1813	\$215.00
240 x 480 Volts	120/240 Volts	2	4	34	14300	9T58K1814	\$274.00
240 x 480 Volts	120/240 Volts	3	4	45	14475	9T58K1815	\$360.00
600 Volts	120/240 Volts	0.1	5	4	8100	9T58K1824	\$45.00
600 Volts	120/240 Volts	0.2	5	6	8175	9T58K1826	\$65.00
600 Volts	120/240 Volts	0.3	5	7	8200	9T58K1828	\$73.00
600 Volts	120/240 Volts	0.5	5	12	10225	9T58K1830	\$104.00
600 Volts	120/240 Volts	1	5	28	14225	9T58K1832	\$194.00
600 Volts	120/240 Volts	2	5	34	14300	9T58K1834	\$306.00
600 Volts	120/240 Volts	3	5	45	14475	9T58K1835	\$398.00

50/60 Hz Leads Out Connection²

Input Voltage	Output Voltage	kVA	Wiring Diagram No. ¹	Approx. Net Weight (Lbs)	Frame Size	Product Number	List Price GO-80
240 x 480 Volts	120/240 Volts	0.25	4	7	8200	9T58K1927	\$63.25
240 x 480 Volts	120/240 Volts	0.5	4	12	10225	9T58K1930	\$104.00
240 x 480 Volts	120/240 Volts	0.75	4	19	12300	9T58K1931	\$133.00
240 x 480 Volts	120/240 Volts	1.5	4	34	14300	9T58K1933	\$221.00
240 x 480 Volts	120/240 Volts	3	4	45	14475	9T58K1935	\$423.00
380/400/416 Volts	115/230 Volts	0.5	8	12	10225	9T58K1978	\$89.90
380/400/416 Volts	115/230 Volts	0.75	8	19	12300	9T58K1979	\$133.00
380/400/416 Volts	115/230 Volts	1	8	28	14225	9T58K1980	\$171.00
380/400/416 Volts	115/230 Volts	1.5	8	34	14300	9T58K1981	\$221.00

¹See page 8-69 for wiring diagrams.

²Secondary fusing not available.

50/60 Hz Universal Voltage/Multitap Terminal Strip Connection

kVA	Frame size	Product Number	List Price GO-80
0.25	10225	9T58K3715	\$143.55
0.35	10225	9T58K3716	\$146.00
0.5	12225	9T58K3717	\$238.60
0.75	12300	9T58K3718	\$280.90
1	14225	9T58K3719	\$302.90
1.5	14300	9T58K3720	\$309.00
2	14475	9T58K3721	\$373.00

Voltage Table

H1 H2	Incoming Voltage				Output Voltage		
	H1 H3	H1 H4	H1 H5	X1 X2	X1 X3	X1 X4	
208			500	85	100	110	
		415		86	104	113	
220	380	440	550	91	110	120	
230	40	460	575	95	115	125	
240	416	480	600	99	120	130	



Publications and Reference: See Section 22 for a complete list of additional product-related publications

Transformers

Open Core and Coil Transformers

Options and Fusing Guide

Encapsulated Transformer Options

Accessory Type	Fuse Type	Product Number	List Price GO-80
Terminal Links (Standard Terminal Blocks)	—	9T58K0000G01	\$0.80
Fuse Blocks Mounted on Top of Transformer	Dual 9/16" x 2" H/K Fuses	9T58K0000G05	\$9.80
Fuse Clips Mounted on Terminals	Single 1/4" x 1 1/4" Glass Fuse	9T58K0000G09 ¹	\$2.05
Fuse Blocks Mounted on Top of Transformer	Single 9/16" x 2" H/K Fuses	9T58K0000G10	\$10.50
Fuse Blocks Mounted on Top of Transformer	Dual 13/32" x 1 1/2" Class CC Fuses with Single 9/16" x 2" H/K Fuse	9T58K0000G18	\$11.80
Fuse Blocks Mounted on Top of Transformer	Single 1/4" x 1 1/4" Glass Fuse	9T58K0000G24	\$4.40
Fuse Blocks Mounted on Top of Transformer	Dual 13/32" x 1 1/2" Class CC Fuses with Single 13/32" x 1 1/2" Midget Fuse	9T58K0000G38	\$14.40
Fuse Blocks Mounted on Top of Transformer	Single 13/32" x 1 1/2" Midget Fuse	9T58K0000G42	\$9.90
Fuse Blocks Mounted on Top of Transformer	Dual 13/32" x 1 1/2" Class CC Fuses with Single 1/4" x 1 1/4" Glass Fuse	9T58K0000G48	\$12.20

¹Terminal Block cover is standard on CE marked designs.

²Use G24 when the transformer is a series multiple or multitapped winding with no open terminals.

Fuse Guide

Midget Class CC Rejection Fuse

Primary Voltage	Encapsulated Transformer Continuous Power Rating (VA)								
	50	75	100	150	200	250	300	375	500
	Fuse Rating (Amperes)								
100	1.50	2.00	3.00	4.00	3.00	4.00	5.00	6.00	8.00
110	1.25	2.00	2.50	4.00	5.00	3.00	4.00	5.00	7.00
120	1.25	1.60	2.50	3.00	5.00	3.00	4.00	5.00	6.00
200	0.75	1.00	1.50	2.00	3.00	3.00	4.00	5.00	4.00
208	0.60	1.00	1.25	2.00	2.50	3.00	4.00	5.00	4.00
220	0.60	1.00	1.25	2.00	2.50	3.00	4.00	5.00	3.00
230	0.60	0.80	1.25	1.60	2.50	3.00	3.00	4.00	3.00
240	0.60	0.80	1.25	1.60	2.50	3.00	3.00	4.00	3.00
277	0.50	0.80	1.00	1.60	2.00	2.50	3.00	4.00	5.00
380	0.30	0.50	0.75	1.00	1.50	1.60	2.00	2.50	3.00
400	0.30	0.50	0.75	1.00	1.50	1.60	2.00	2.50	3.00
416	0.30	0.50	0.60	1.00	1.25	1.60	2.00	2.50	3.00
440	0.30	0.50	0.60	1.00	1.25	1.60	2.00	2.50	3.00
460	0.30	0.40	0.60	0.80	1.25	1.60	1.60	2.00	3.00
480	0.30	0.40	0.60	0.80	1.25	1.50	1.60	2.00	3.00
550	0.25	0.40	0.50	0.80	1.00	1.25	1.60	2.00	2.50
575	0.25	0.30	0.50	0.75	1.00	1.25	1.50	1.60	2.50
600	0.25	0.30	0.50	0.75	1.00	1.25	1.50	1.60	2.50

For motor control circuits fusing, refer to NEC 430-72.

Secondary Fuse Selection

Glass Fuse

Secondary Voltage	Encapsulated Transformer Continuous Power Rating (VA)													
	50	75	100	150	200	250	300	375	500	750	1000	1500	2000	3000
	Fuse Rating (Amperes)													
12	6.00	10.00	12.00	15.00	20.00	25.00	30.00	—	—	—	—	—	—	—
24	3.00	5.00	6.00	10.00	12.00	12.00	15.00	—	25.00	—	—	—	—	—
36	2.00	3.00	4.00	6.00	8.00	10.00	12.00	—	15.00	—	—	—	—	—
48	1.50	2.50	3.00	5.00	6.00	8.00	10.00	12.00	12.00	—	—	—	—	—
95	0.80	1.25	1.60	2.50	3.00	4.00	5.00	6.00	8.00	12.00	15.00	20.00	25.00	—
110	0.75	1.00	1.50	2.00	3.00	3.00	4.00	5.00	7.00	10.00	12.00	20.00	25.00	30.00
115	0.60	1.00	1.25	2.00	2.50	3.00	4.00	5.00	7.00	10.00	12.00	20.00	20.00	30.00
120	0.60	1.00	1.25	2.00	2.50	3.00	4.00	5.00	6.00	10.00	12.00	15.00	20.00	30.00
208	0.40	0.60	0.80	1.00	1.60	2.00	2.00	3.00	4.00	6.00	8.00	12.00	15.00	20.00
220	0.30	0.50	0.75	1.00	1.50	1.60	2.00	2.50	3.00	5.00	7.00	10.00	12.00	20.00
230	0.30	0.50	0.60	1.00	1.25	1.60	2.00	2.50	3.00	5.00	7.00	10.00	12.00	20.00
240	0.30	0.50	0.60	1.00	1.25	1.60	2.00	2.50	3.00	5.00	6.00	10.00	12.00	15.00



Transformers

Open Core and Coil Transformers

Machine Tool Applications

Control
Wiring Diagrams

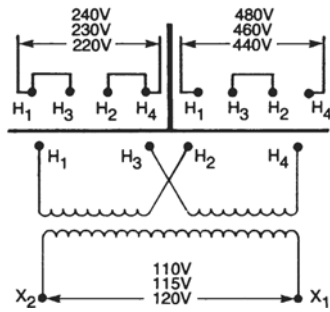

Diagram 1

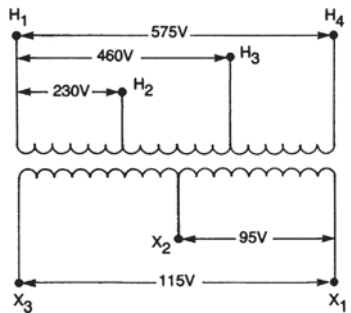

Diagram 2

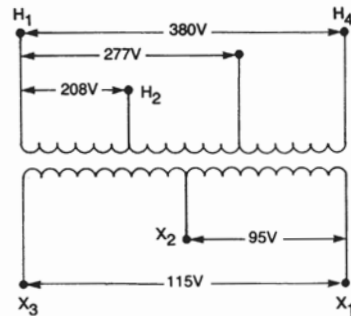

Diagram 3

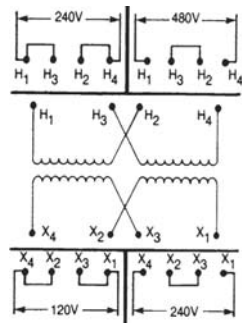

Diagram 4

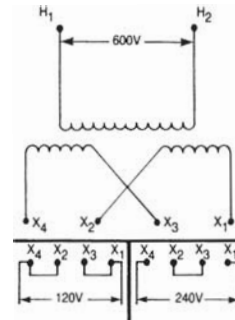

Diagram 5

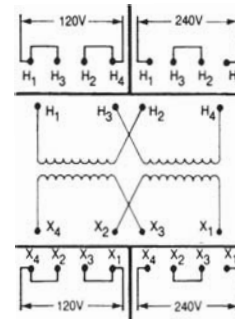

Diagram 6

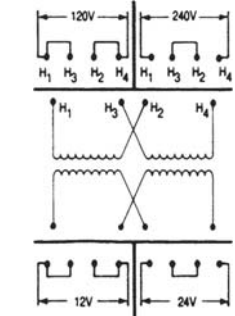

Diagram 7

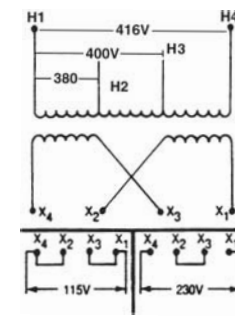

Diagram 8



Publications and Reference: See Section 22 for a complete list of additional product-related publications

Transformers

Open Core and Coil Transformers

Outlines and Dimensions

6, 8 and 10 Frame

Section 8

Terminal Board Connection Style

Frame Size	kVA	Approx. Net Weight (Lbs.)	A Depth (in.)	B Width (in.)	C Height (in.)	Mounting Depth E (in.)	Mounting Width F (in.)	Mounting Slot (in.)
6100	0.05	2.6	4	3.06	2.68	2.16	2.5	.219 x .750
6125	0.075	3	4.25	3.06	2.68	2.41	2.5	.219 x .750
8100	0.1	3.9	4.12	3.81	3.28	2.16	3.12	.219 x .750
8150	0.15	5.5	4.62	3.81	3.28	2.66	3.12	.219 x .750
8175	0.2	6.3	4.88	3.81	3.28	2.91	3.12	.219 x .750
8200	0.25	7	5.12	3.81	3.28	3.16	3.12	.219 x .750
8250	0.375	8.3	5.62	3.81	3.28	3.66	3.12	.219 x .750
10225	0.5	11.6	5.75	4.56	3.9	3.38	3.75	.297 x .580
12225	0.75	13	5.81	5.31	4.56	3.38	4	.297 x .580
12300	1	17.5	6.56	5.31	4.56	4.13	4	.297 x .580
14225	1.5	29	6.31	6.81	5.81	3.38	5.5	.297 x .580
14300	2	35.5	7.06	6.81	5.81	4.13	5.5	.297 x .580
14475	3	51.5	8.81	6.81	5.81	5.88	5.5	.297 x .580

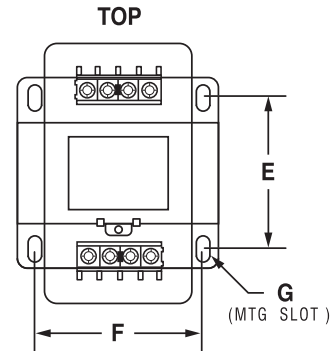

Leads Out Connection Style

Frame Size	kVA	Approx. Net Weight (Lbs.)	A Depth (in.)	B Width (in.)	C Height (in.)	Mounting Depth E (in.)	Mounting Width F (in.)	Mounting Slot (in.)
6100	0.05	2.6	3.25	3.06	2.68	2.16	2.5	.219 x .750
6125	0.075	3	3.5	3.06	2.68	2.41	2.5	.219 x .750
8100	0.1	3.9	3.42	3.81	3.28	2.16	3.12	.219 x .750
8150	0.15	5.5	3.92	3.81	3.28	2.66	3.12	.219 x .750
8175	0.2	6.3	4.18	3.81	3.28	2.91	3.12	.219 x .750
8200	0.25	7	4.42	3.81	3.28	3.16	3.12	.219 x .750
8200	0.3	7	4.42	3.81	3.28	3.16	3.12	.219 x .750
8250	0.375	8.3	4.92	3.81	3.28	3.66	3.12	.219 x .750
10225	0.5	11.6	5.75	4.56	3.9	3.38	3.75	.297 x .580
10225	0.75	13	5.81	5.31	4.56	3.38	4	.297 x .580
12300	1	17.5	6.56	5.31	4.56	4.13	4	.297 x .580
14225	1.5	29	6.31	6.81	5.81	3.38	5.5	.297 x .580
14300	2	35.5	7.06	6.81	5.81	4.13	5.5	.297 x .580
14475	3	51.5	8.81	6.81	5.81	5.88	5.5	.297 x .580

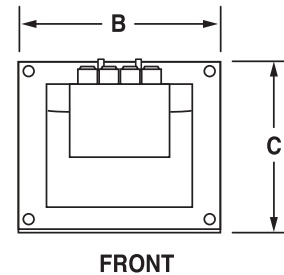

Terminal Board Connection Style

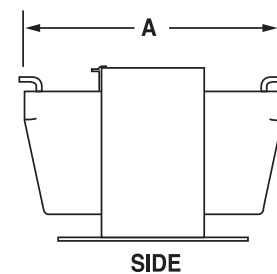
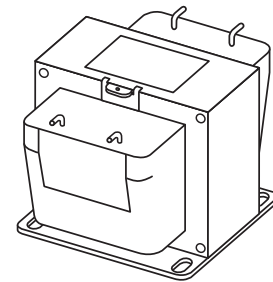

Leads Out Connection Style



Transformers

Open Core and Coil Transformers

CE-Rated

Application

This product is designed to be incorporated into equipment manufactured for sale in the European Community. This product is in conformity with the European Standard:

EN 60 742, 1995 per the provisions of the Low Voltage (LV) Directive 73/23/EEC in 1973 as amended by 93/68/EEC in 1995.

The Type "IP" CE offering utilizes all copper windings, which are encapsulated in a hardened epoxy, making the winding impervious to the elements. These designs are rated at 55° C rise with a 40° C ambient. Standard on these designs are terminal board covers. These provide added protection from current carrying terminals. These designs incorporate customer friendly connection on rugged high-impact molded terminal boards.

Besides being CE rated, these designs are both UL and C-UL listed.

50/60 Hz

Input Voltage	Output Voltage	kVA	Approx. Net Weight (Lbs)	Frame Size	Product Number	List Price GO-80
230/400 Volts	12/24 Volts	0.025	3	6100	9T58E0020	\$36.00
230/400 Volts	12/24 Volts	0.05	4	6150	9T58E0021	\$40.00
230/400 Volts	12/24 Volts	0.075	4	8100	9T58E0023	\$46.00
230/400 Volts	12/24 Volts	0.1	5	8150	9T58E0024	\$49.00
230/400 Volts	12/24 Volts	0.15	7	8200	9T58E0025	\$61.00
230/400 Volts	12/24 Volts	0.2	12	10225	9T58E0026	\$81.00
230/400 Volts	12/24 Volts	0.25	12	10225	9T58E0027	\$91.00
230/400 Volts	12/24 Volts	0.3	12	10225	9T58E0028	\$100.00
230/400 Volts	12/24 Volts	0.375	16	12225	9T58E0029	\$114.00
230/400 Volts	24/48 Volts	0.05	4	6150	9T58E0061	\$40.00
230/400 Volts	24/48 Volts	0.075	4	8100	9T58E0063	\$46.00
230/400 Volts	24/48 Volts	0.1	5	8150	9T58E0064	\$49.00
230/400 Volts	24/48 Volts	0.15	7	8200	9T58E0065	\$61.00
230/400 Volts	24/48 Volts	0.2	12	10225	9T58E0066	\$81.00
230/400 Volts	24/48 Volts	0.5	19	12300	9T58E0071	\$139.00
230/400 Volts	24/48 Volts	0.75	28	14225	9T58E0073	\$189.00
220/380, 230/400, 240/415 Volts	110/220, 115/230, 120/240 Volts	0.025	3	6100	9T58E0150	\$36.00
220/380, 230/400, 240/415 Volts	110/220, 115/230, 120/240 Volts	0.05	4	6150	9T58E0151	\$40.00
220/380, 230/400, 240/415 Volts	110/220, 115/230, 120/240 Volts	0.075	4	8100	9T58E0153	\$46.00
220/380, 230/400, 240/415 Volts	110/220, 115/230, 120/240 Volts	0.1	5	8150	9T58E0154	\$49.00
220/380, 230/400, 240/415 Volts	110/220, 115/230, 120/240 Volts	0.15	7	8200	9T58E0155	\$61.00
220/380, 230/400, 240/415 Volts	110/220, 115/230, 120/240 Volts	0.2	12	10225	9T58E0156	\$81.00
220/380, 230/400, 240/415 Volts	110/220, 115/230, 120/240 Volts	0.25	12	10225	9T58E0157	\$91.00
220/380, 230/400, 240/415 Volts	110/220, 115/230, 120/240 Volts	0.3	12	10225	9T58E0158	\$100.00
220/380, 230/400, 240/415 Volts	110/220, 115/230, 120/240 Volts	0.375	16	12225	9T58E0159	\$114.00
220/380, 230/400, 240/415 Volts	110/220, 115/230, 120/240 Volts	0.5	19	12300	9T58E0161	\$139.00
220/380, 230/400, 240/415 Volts	110/220, 115/230, 120/240 Volts	0.75	28	14225	9T58E0163	\$189.00
220/380, 230/400, 240/415 Volts	110/220, 115/230, 120/240 Volts	1	34	14300	9T58E0164	\$196.00
220/380, 230/400, 240/415 Volts	110/220, 115/230, 120/240 Volts	1.5	45	14475	9T58E0165	\$253.00

Factory- or Field-Installed Options

Available as an option are two fuse blocks that have fuse covers that provide the touch safety like the terminal blocks. These can be ordered factory-installed or as kits.

In kit form order:

Fuse block for 2 class CC fuses is 9T58E0000G46, **List Price, \$28.00, GO-80.** Fuse block for 2 class CC and 1 Midget fuse is 9T58E0000G47, **List Price, \$42.00, GO-80.**

For factory installation add the G46 or G47 suffix to the transformer product number (example 9T58E0020G47).



Publications and Reference: See Section 22 for a complete list of additional product-related publications

